



MMIC SURFACE MOUNT

Power Amplifier

PMA5-123-3W+

Mini-Circuits

50Ω 8 to 12 GHz 3.5 W P_{SAT}

THE BIG DEAL

- High Gain, Typ. 28.3 dB
- High P_{SAT}, Typ. +35.7 dBm
- Excellent PAE, Typ. 30%
- Supply Voltage, +7 V @ 1250 mA
- Integrated Power Detector
- 5x5 mm 32-Lead QFN-Style Package

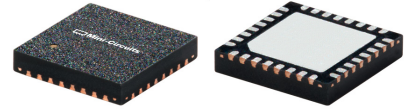

Generic photo used for illustration purposes only

APPLICATIONS

- Radar, EW, and ECM Defense Systems
- MIMO Wireless Infrastructure Systems
- Microwave Radio & VSAT

FUNCTIONAL DIAGRAM

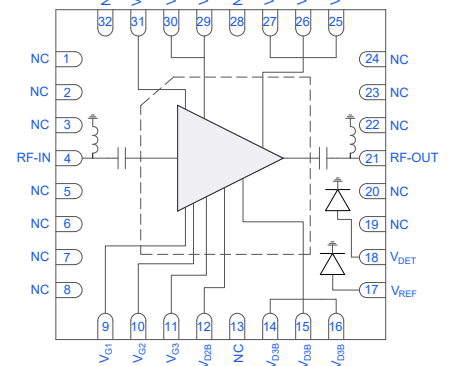

PRODUCT OVERVIEW

Mini-Circuits' PMA5-123-3W+ is a GaAs MMIC power amplifier operating from 8 to 12 GHz. This internally matched 50Ω amplifier provides 28.3 dB of gain, +35.7 dBm saturated output power, and +43.8 dBm output IP3, while operating from a +7 V power supply and consuming 1250 mA of current. In addition, an integrated power detector allows for seamless output power monitoring. These characteristics make it ideally suited for microwave radio, satellite communications, and radar systems that require high operating output power, while maintaining very low distortion characteristics.

KEY FEATURES

Features	Advantages
High P _{SAT} Typ. +35.7 dBm	With 3.5 W of output power, this device can be used as a driver stage or as the power amplifier in microwave radio, satellite communications, or radar systems.
High Efficiency PAE Typ. 30%	Best in-class PAE allows for system power conservation and reduced thermal dissipation.
Integrated Power Detector	An on-chip power detector provides a log-linear output voltage over a 0 to +35 dBm output power range. Useful for power monitoring systems with dynamic gain and output power control.
5x5 mm 32-Lead QFN-Style Package	Small footprint saves space in dense layouts while providing low inductance, repeatable transitions, and excellent thermal contact to the PCB. Industry standard packaging allows for ease of assembly in high volume manufacturing processes.





MMIC SURFACE MOUNT

Power Amplifier

PMA5-123-3W+

Mini-Circuits

50Ω 8 to 12 GHz 3.5 W P_{SAT}ELECTRICAL SPECIFICATIONS¹ AT +25°C, V_{DD} = +7 V, UNLESS NOTED OTHERWISE

Parameter	Condition (GHz)	Min.	Typ.	Max.	Units
Frequency Range		8		12	GHz
Gain	8		27.7		dB
	9		29.0		
	10		28.3		
	11		28.3		
	12		28.7		
Output Power at 1 dB Compression (P1dB)	8		+33.5		dBm
	9		+35.2		
	10		+34.4		
	11		+34.3		
	12		+33.6		
Output Power at Saturation (P _{SAT}) ²	8		+34.4		dBm
	9		+36.1		
	10		+35.7		
	11		+35.9		
	12		+35.8		
Power Added Efficiency (PAE) at P _{SAT}			30		%
Output Third-Order Intercept (P _{OUT} = +20 dBm/Tone)	8		+41.8		dBm
	9		+43.3		
	10		+43.8		
	11		+43.0		
	12		+40.8		
Input Return Loss	8		18		dB
	9		13		
	10		13		
	11		10		
	12		12		
Output Return Loss	8		10		dB
	9		14		
	10		20		
	11		13		
	12		8		
Isolation	8		66		dB
	9		64		
	10		64		
	11		59		
	12		57		
Noise Figure	8		8.7		dB
	9		7.7		
	10		6.9		
	11		6.3		
	12		6.1		
Power Detector Range			0 to +35		dBm
Device Operating Voltage (V _{DD}) ³		+6	+7	+8	V
Device Operating Current (I _{DD}) ⁴			1250		mA
Device Gate Voltage (V _{GG}) ⁵			-0.75		V
Device Gate Current (I _{GG})				14	mA
DC Current Variation vs. Temperature ⁶			-10		μA/°C
DC Current Variation vs. Voltage ⁷			-1.56		μA/mV

1. Tested on Mini-Circuits Characterization Test Board TB-PMA5-1233WC+. See Figure 2. Loss de-embedded to the RF input and output pins of the device.

2. P_{SAT} is defined as when the Output Power changes 0.1 dB per 1 dB change in Input Power.

3. V_{DD} = V_{D1} = V_{D2} = V_{D3} = V_{D2B} = V_{D3B}

4. Current at P_{IN} = -10 dBm. Increases to 1450 mA at P1dB.

5. V_{GG} = V_{G1} = V_{G2} = V_{G3}

6. (Current at +85°C - Current at -45°C)/(130°C)

7. (Current at +8 V - Current at +6 V)/(+2 V)





MMIC SURFACE MOUNT

Power Amplifier

PMA5-123-3W+

Mini-Circuits

50Ω 8 to 12 GHz 3.5 W P_{SAT}

TYPICAL PERFORMANCE GRAPHS

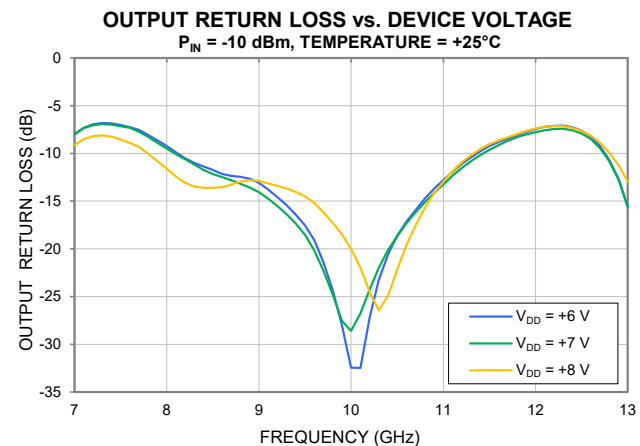
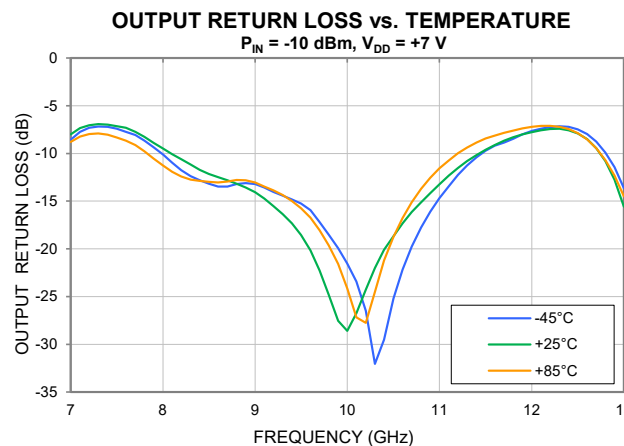
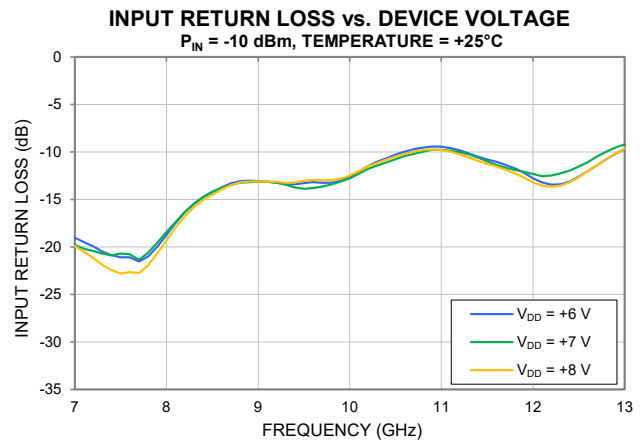
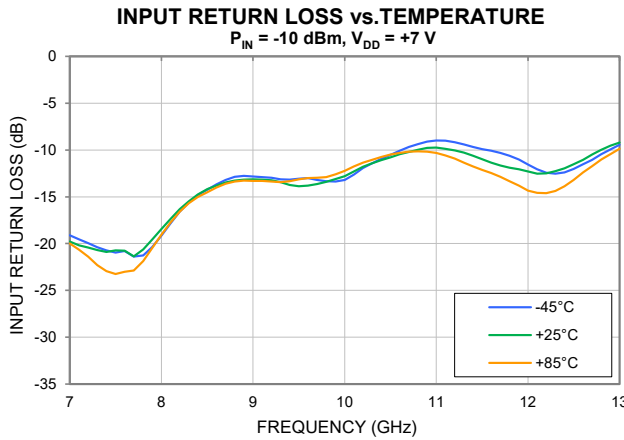
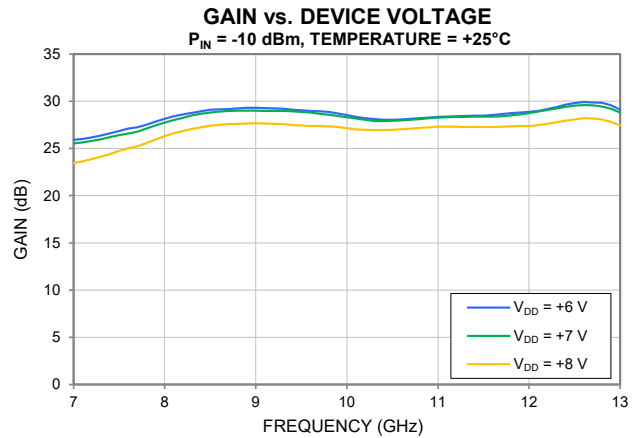
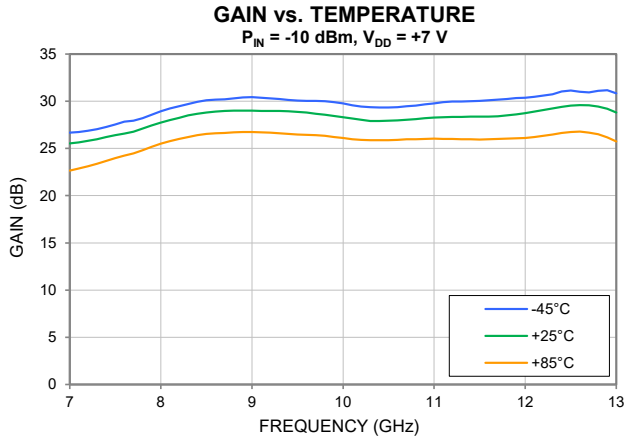



MMIC SURFACE MOUNT

Power Amplifier

PMA5-123-3W+

Mini-Circuits

50Ω 8 to 12 GHz 3.5 W P_{SAT}

TYPICAL PERFORMANCE GRAPHS

ISOLATION vs. TEMPERATURE

P_{IN} = -10 dBm, V_{DD} = +7 V

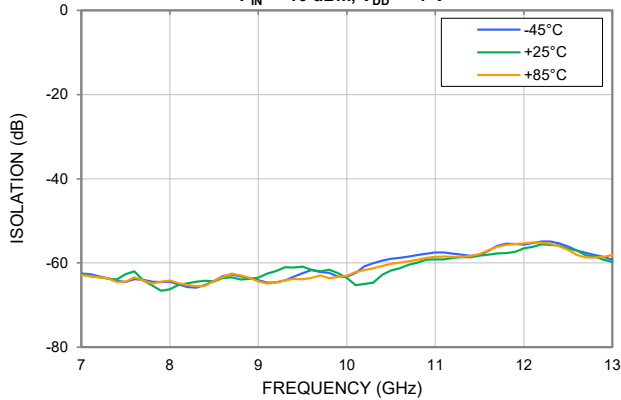

ISOLATION vs. DEVICE VOLTAGE

P_{IN} = -10 dBm, TEMPERATURE = +25°C

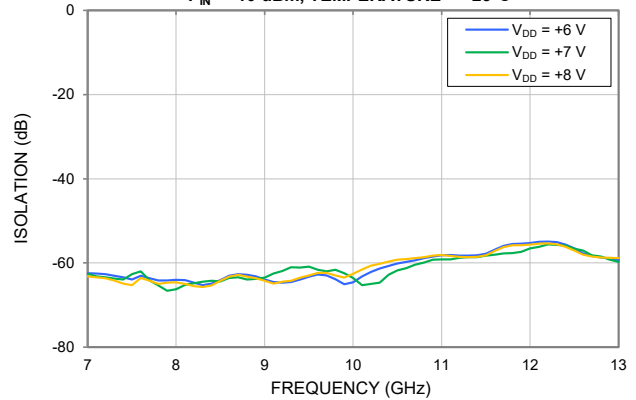

P_{1dB} vs. TEMPERATURE

V_{DD} = +7 V

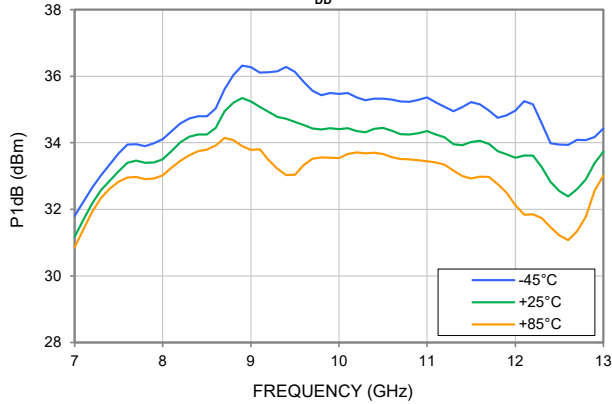

P_{1dB} vs. DEVICE VOLTAGE

TEMPERATURE = +25°C

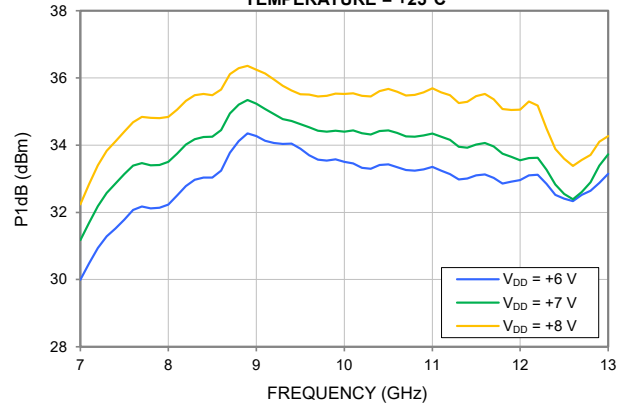

P_{SAT} vs. TEMPERATURE

V_{DD} = +7 V

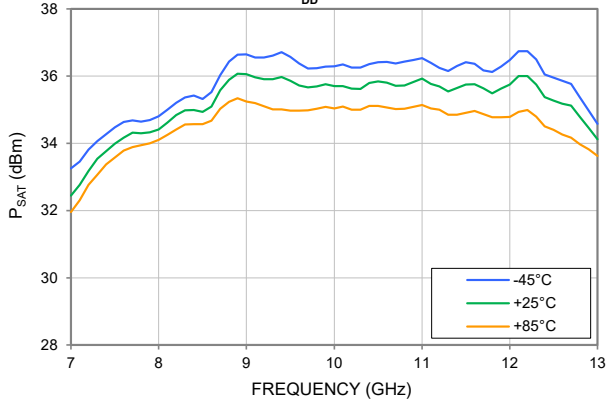

P_{SAT} vs. DEVICE VOLTAGE

TEMPERATURE = +25°C

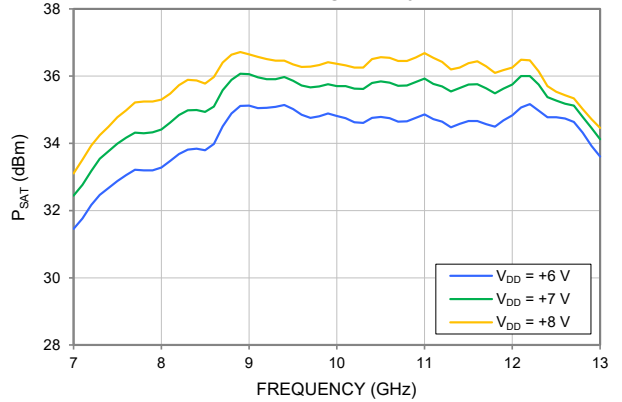



TYPICAL PERFORMANCE GRAPHS

OUTPUT IP3 vs. TEMPERATURE

P_{OUT} = +20 dBm/TONE, V_{DD} = +7 V,
TONE SPACING = 5 MHz

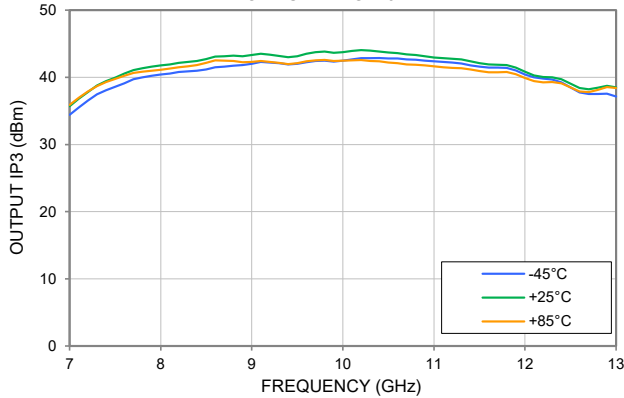

OUTPUT IP3 vs. DEVICE VOLTAGE

P_{OUT} = +20 dBm/TONE, TONE SPACING = 5 MHz,
TEMPERATURE = +25°C

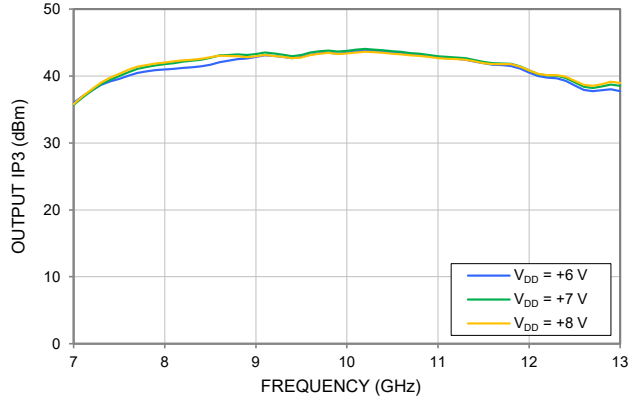

IM3 vs. TEMPERATURE

P_{OUT} = +20 dBm/TONE, V_{DD} = +7 V,
TONE SPACING = 5 MHz

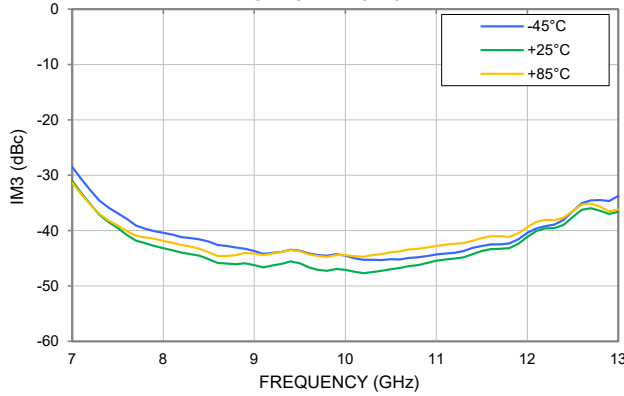

IM3 vs. DEVICE VOLTAGE

P_{OUT} = +20 dBm/TONE, TONE SPACING = 5 MHz,
TEMPERATURE = +25°C

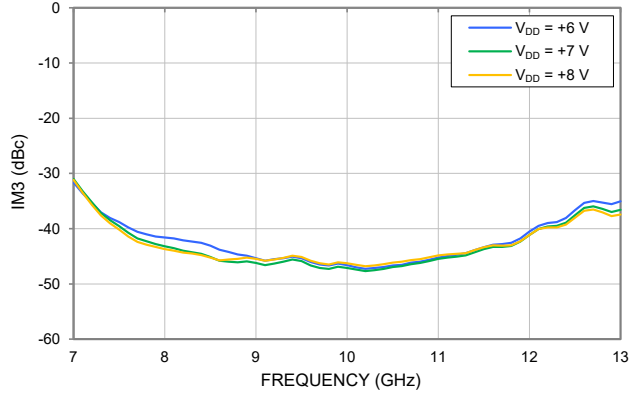

NOISE FIGURE vs. TEMPERATURE

V_{DD} = +7 V

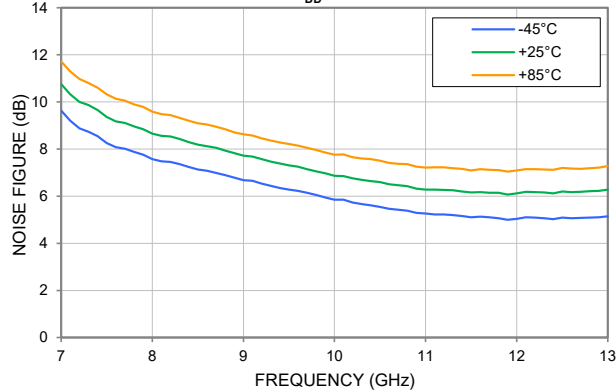

NOISE FIGURE vs. DEVICE VOLTAGE

TEMPERATURE = +25°C

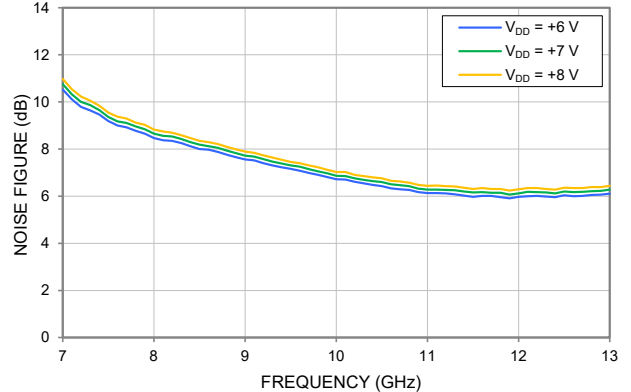



MMIC SURFACE MOUNT

Power Amplifier

PMA5-123-3W+

Mini-Circuits

50Ω 8 to 12 GHz 3.5 W P_{SAT}

TYPICAL PERFORMANCE GRAPHS

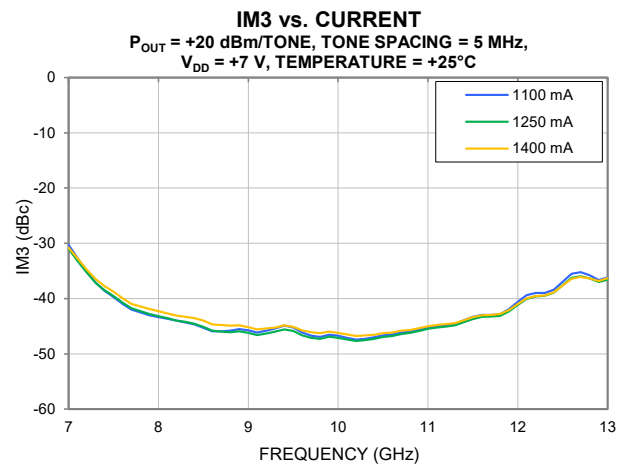
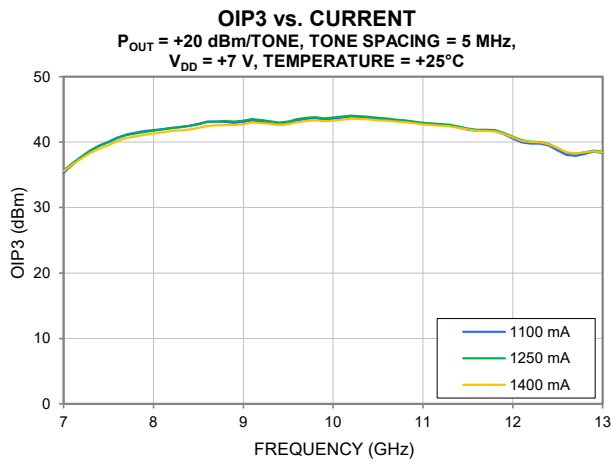
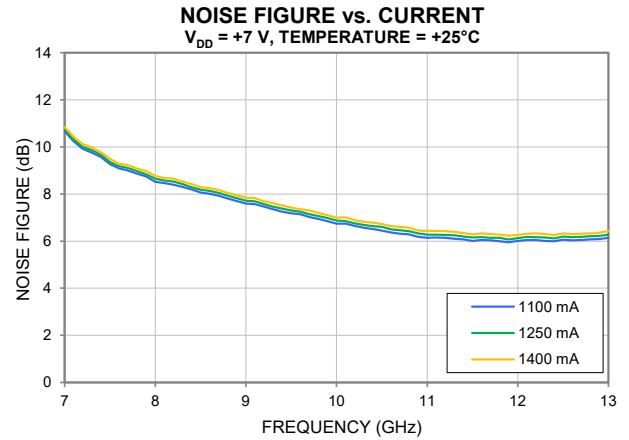
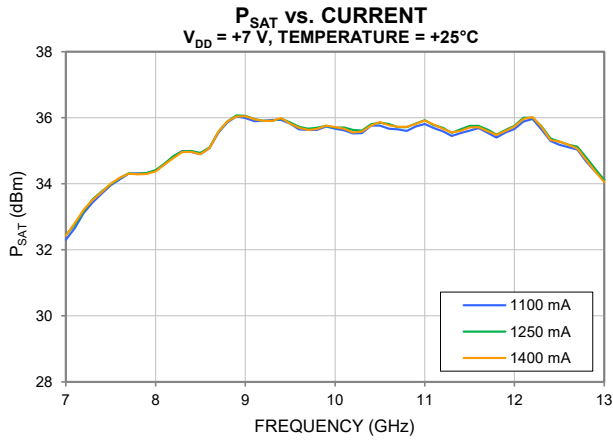
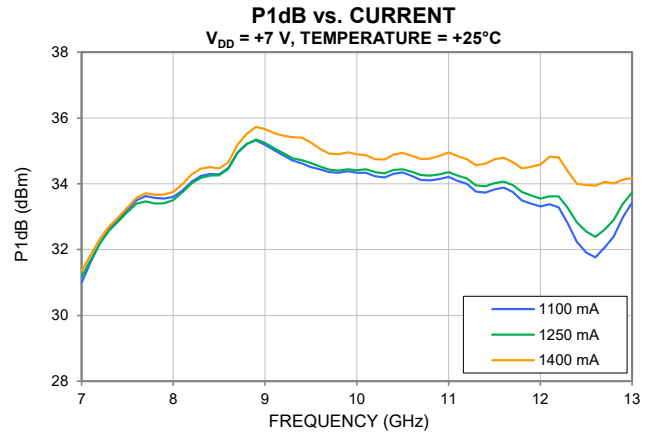
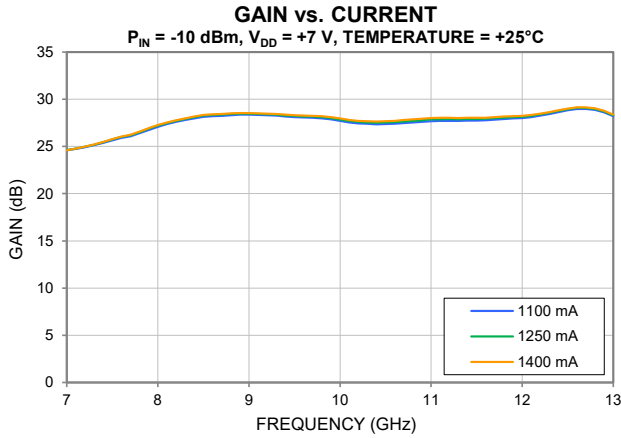



MMIC SURFACE MOUNT

Power Amplifier

PMA5-123-3W+

Mini-Circuits

50Ω 8 to 12 GHz 3.5 W P_{SAT}

TYPICAL PERFORMANCE GRAPHS

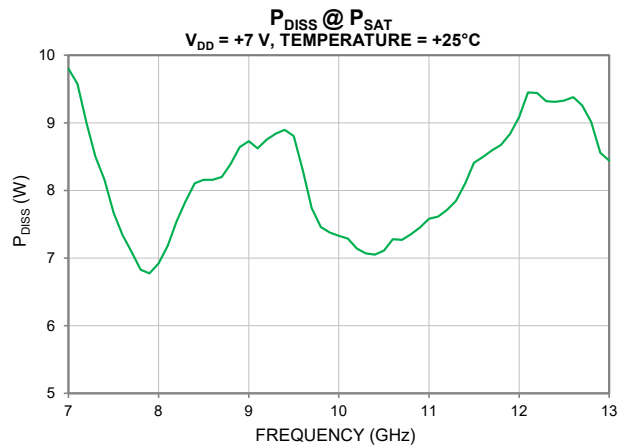
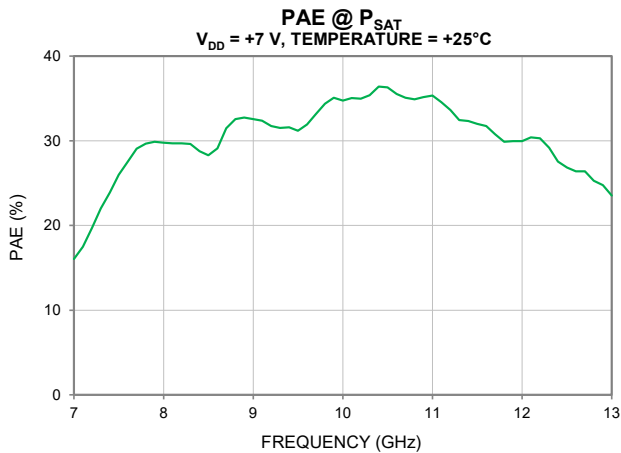
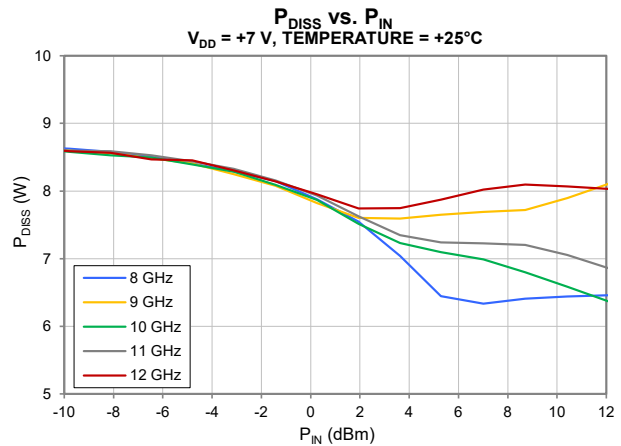
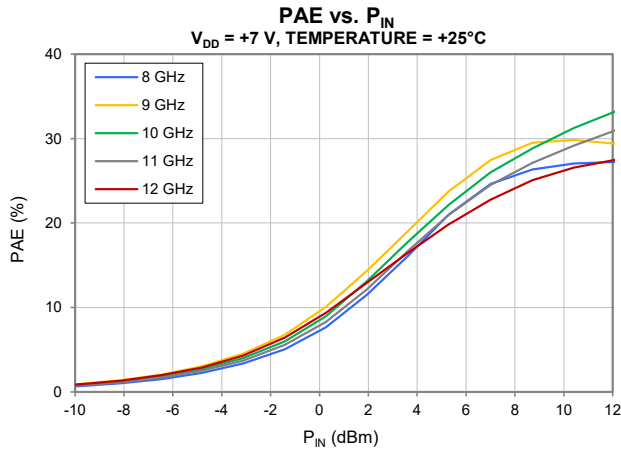
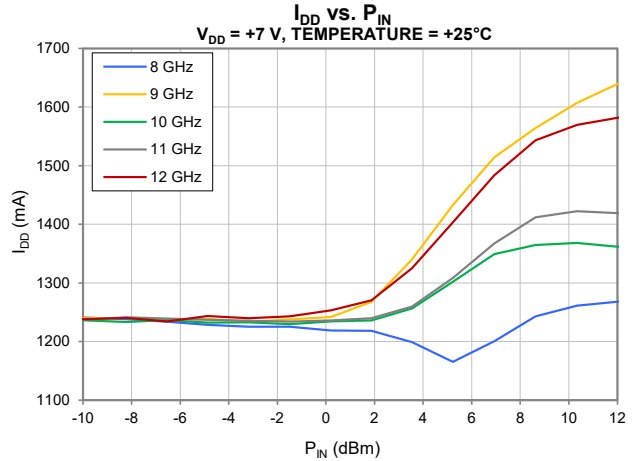
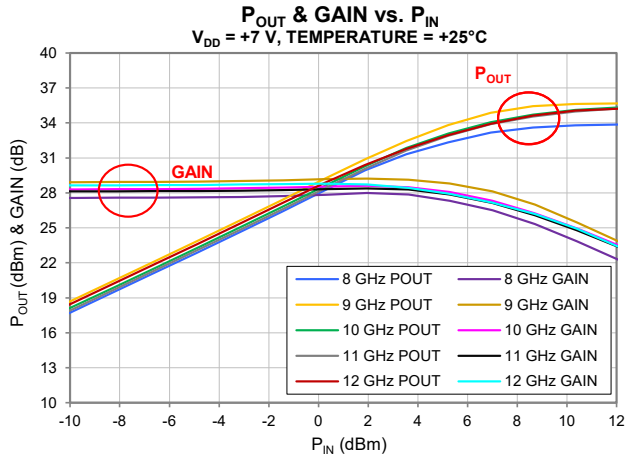



MMIC SURFACE MOUNT

Power Amplifier

PMA5-123-3W+

Mini-Circuits

50Ω 8 to 12 GHz 3.5 W P_{SAT}

TYPICAL PERFORMANCE GRAPHS

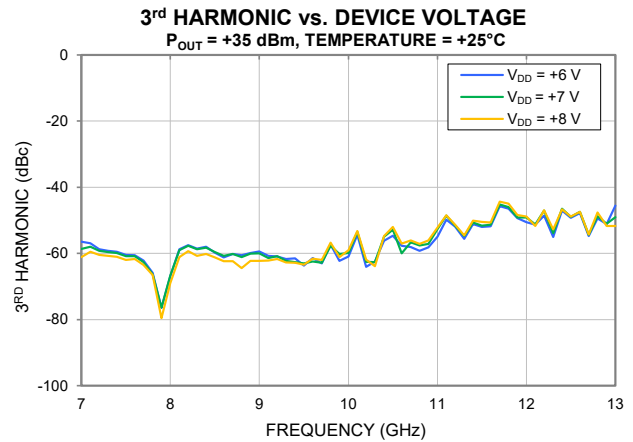
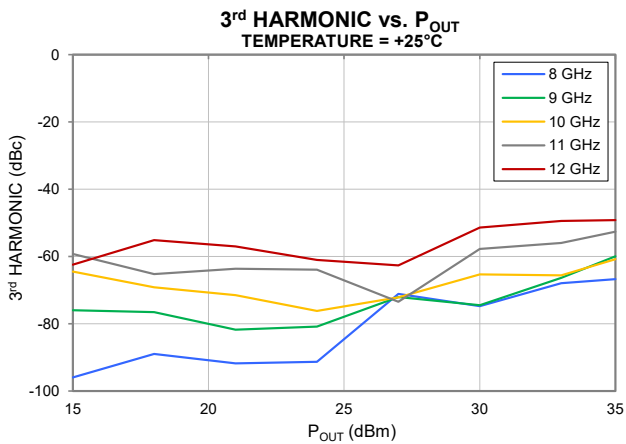
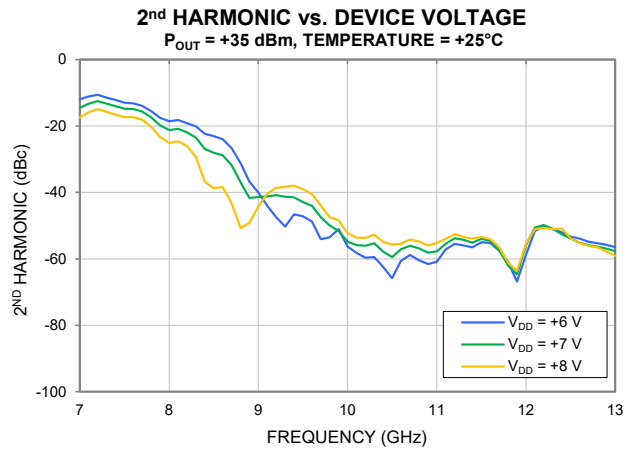
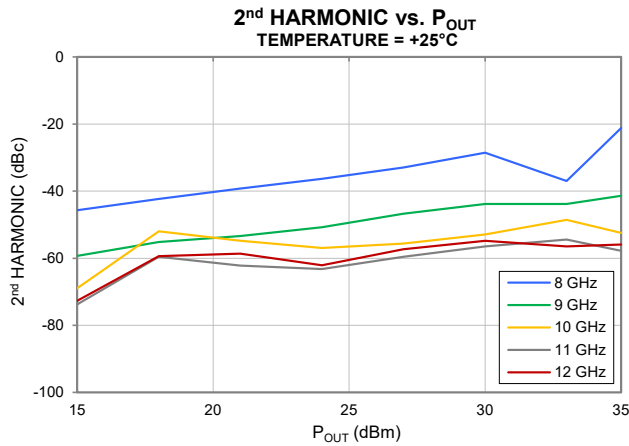
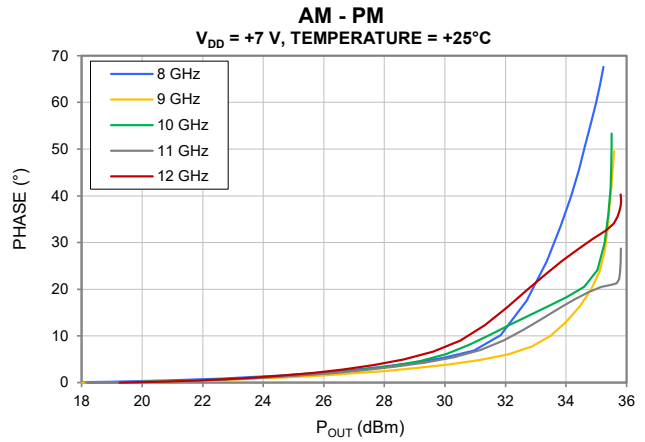
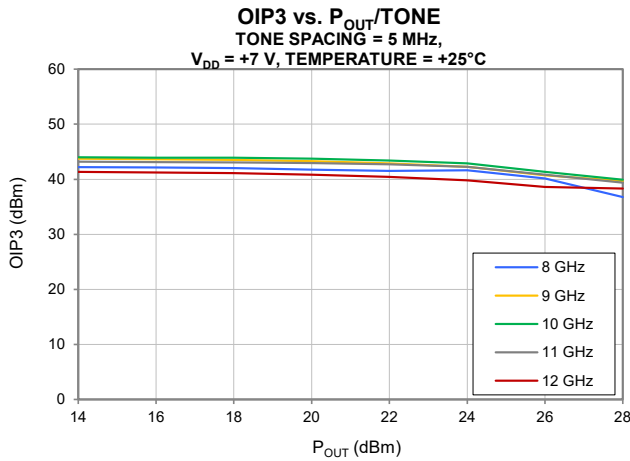



MMIC SURFACE MOUNT

Power Amplifier

PMA5-123-3W+

Mini-Circuits

50Ω 8 to 12 GHz 3.5 W P_{SAT}

TYPICAL PERFORMANCE GRAPHS

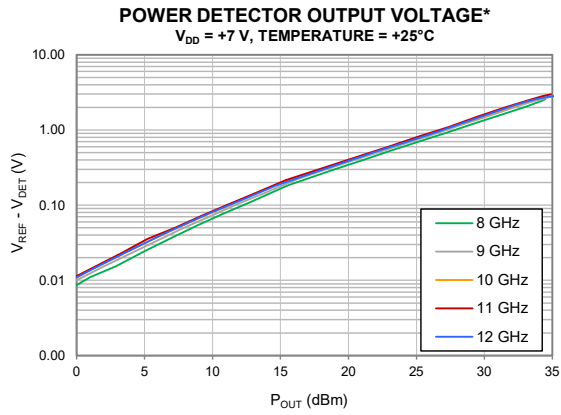

* Logarithmic scale base 10

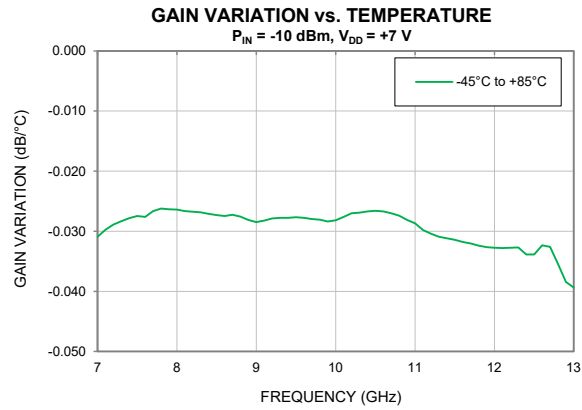



MMIC SURFACE MOUNT

Power Amplifier

PMA5-123-3W+

Mini-Circuits

50Ω 8 to 12 GHz 3.5 W P_{SAT}

ABSOLUTE MAXIMUM RATINGS⁸

Parameter	Ratings
Operating Temperature ⁹	-45°C to +85°C
Storage Temperature	-65°C to +150°C
Junction Temperature ¹⁰	+175°C
Total Power Dissipation	14.7 W
Input Power (CW), V _{DD} = +7 V	+27 dBm
DC Drain Voltage at V _{DD} ¹¹	+8.5 V
DC Gate Voltage at V _{GG} ¹²	-3.0 V (min) / -0.4 V (max)
DC Drain Current I _{DD}	3 A
DC Gate Current I _{GG}	14 mA

8. Permanent damage may occur if these limits are exceeded. Maximum ratings are not intended for continuous normal operation.

9. Bottom of Die.

10. Peak temperature on top of Die.

11. V_{DD} = V_{D1} = V_{D2} = V_{D3} = V_{D2B} = V_{D3B}

12. V_{GG} = V_{G1} = V_{G2} = V_{G3}

THERMAL RESISTANCE

Parameter	Ratings
Thermal Resistance (Θ _{JC}) ¹³	7.7°C/W

13. Θ_{JC} = (Hot Spot Temperature on Die - Temperature at Ground Lead)/Dissipated Power

ESD RATING

	Class	Voltage Range	Reference Standard
HBM	1B	500 V to < 1000 V	ANSI/ESDA/JEDEC JS-001-2023
CDM	C3	≥ 1000 V	ANSI/ESDA/JEDEC JS-002-2022



ESD HANDLING PRECAUTION: This device is designed to be Class 1B for HBM. Static charges may easily produce potentials higher than this with improper handling and can discharge into DUT and damage it. As a preventive measure Industry standard ESD handling precautions should be used at all times to protect the device from ESD damage.

MSL RATING

Moisture Sensitivity: MSL1 in accordance with IPC/JEDEC J-STD-020E/JEDEC J-STD-033C





FUNCTIONAL DIAGRAM

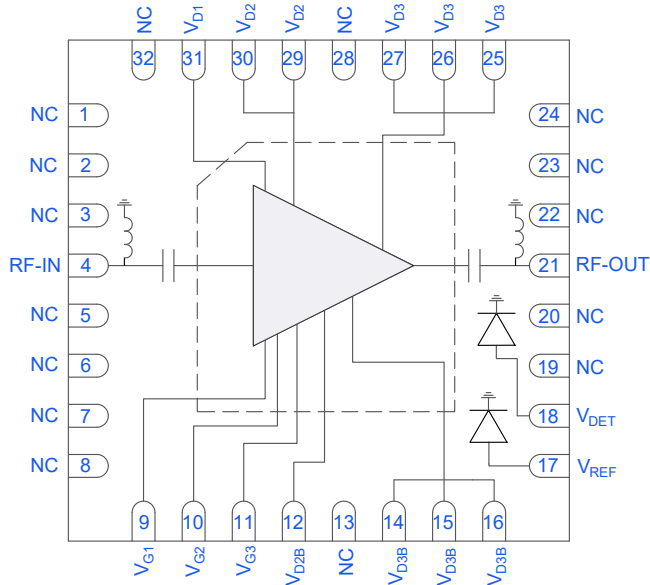

Figure 1. PMA5-123-3W+ Functional Diagram

PAD DESCRIPTION

Function	Pad Number	Description (Refer to Figure 1)
RF-IN	4	RF-IN pad connects to RF Input port.
RF-OUT	21	RF-OUT pad connects to RF Output port.
V _{D1}	31	DC Input pad connects to First Stage Drain Voltage port.
V _{G1}	9	DC Input pad connects to First Stage Gate Voltage port.
V _{D2}	29, 30	DC Input pad connects to Second Stage Drain Voltage port.
V _{G2}	10	DC Input pad connect to Second Stage Gate Voltage port.
V _{D3}	25, 26, 27	DC Input pad connects to Third Stage Drain Voltage port.
V _{G3}	11	DC Input pad connects to Third Stage Gate Voltage port.
V _{D2B} ¹⁴	12	DC Input pad connects to Second Stage Drain Voltage Alternate port.
V _{D3B} ¹⁵	14, 15, 16	DC Input pad connect to Third Stage Drain Voltage Alternate port.
V _{DET}	18	DC Output pad connects to Power Detector Output Voltage port. Voltage is proportional to RF Output Power.
V _{REF}	17	DC Output pad connects to Power Detector Reference Voltage port.
NC	1-3, 5-8, 13, 19, 20, 22-24, 28, 32	Not used internally. Connected to ground on test board.
GND	Paddle	Connects to ground.

14. V_{D2B} can be used as an alternate to V_{D2}. V_{D2B} and V_{D2} are connected internally. Voltage may be applied to both ports. On the Evaluation Circuit, DC bias is only applied to V_{D2}.
 15. V_{D3B} can be used as an alternate to V_{D3}. V_{D3B} and V_{D3} are connected internally. For optimal performance voltage should be applied to both ports. On the Evaluation Circuit, DC bias is applied to both V_{D3} and V_{D3B}. During characterization, V_{D3} and V_{D3B} were connected via a jumper.



EVALUATION BOARD

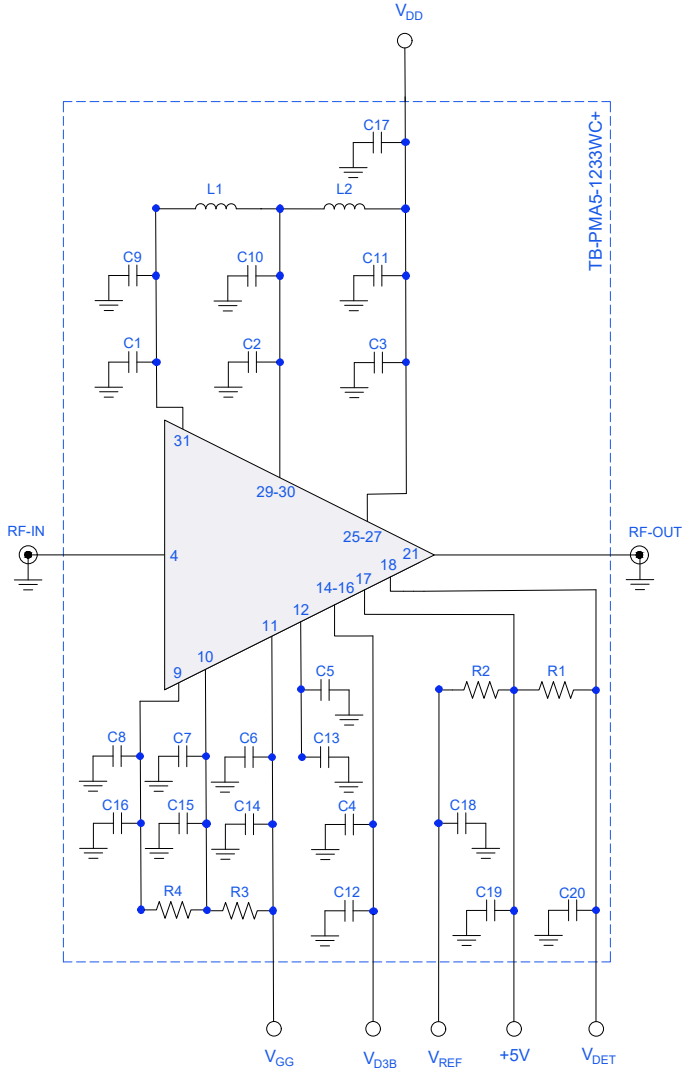

Electrical Parameters and Conditions

Gain, Return Loss, Output Power at 1 dB Compression (P1dB), Output IP3 (OIP3), and Noise Figure measured using N5247B PNA-X Microwave Network Analyzer.

Conditions:

- a. Gain and Return Loss: P_{IN} = -10 dBm
- b. Output IP3 (OIP3): Two tones, spaced 5 MHz apart, +20 dBm/Tone at output.

Power ON/Power OFF Sequence¹⁶

Caution: Permanent damage to the device will occur if the Power ON and Power OFF sequences are not followed.

POWER ON:

- 1) Set V_{GG} = -1.5 V. Apply V_{GG}.
- 2) Set V_{DD} = +7 V. Apply V_{DD}.
- 3) Increase V_{GG} to obtain desired I_{DD} as shown in spec table.
- 4) Apply RF Signal.

POWER OFF:

- 1) Turn off RF Signal.
- 2) Adjust V_{GG} down to -1.5 V.
- 3) Turn off V_{DD}.
- 4) Turn off V_{GG}.

16. In instances of applying V_{DD}, V_{D3B} may be applied along with V_{D3} via a jumper for optimal performance.

Figure 2. PMA5-123-3W+ Evaluation and Characterization Circuit

Component	Value	Size	Part Number	Manufacturer
C1 – C8	0.001 μF	0402	GRM1555C1H102JA01D	MURATA
C9 – C16, C18 – C20	0.1 μF	0402	GRM155R71E104KE14D	MURATA
C17	47 μF	1206	1206YD476MAT2A	KYOCERA AVX
L1, L2	150 nH	0402	0402DF-151XJRW	COILCRAFT
R1, R2	100kΩ	0402	RK73H1ETTP1003F	KOA SPEER
R3	0Ω	0402	RK73Z1ETTP	KOA SPEER
R4	100Ω	0402	RK73H1ETTP1000F	KOA SPEER



MMIC SURFACE MOUNT

Power Amplifier

PMA5-123-3W+

Mini-Circuits

50Ω 8 to 12 GHz 3.5 W P_{SAT}

EVALUATION BOARD & RECOMMENDED POWER DETECTOR CIRCUITRY

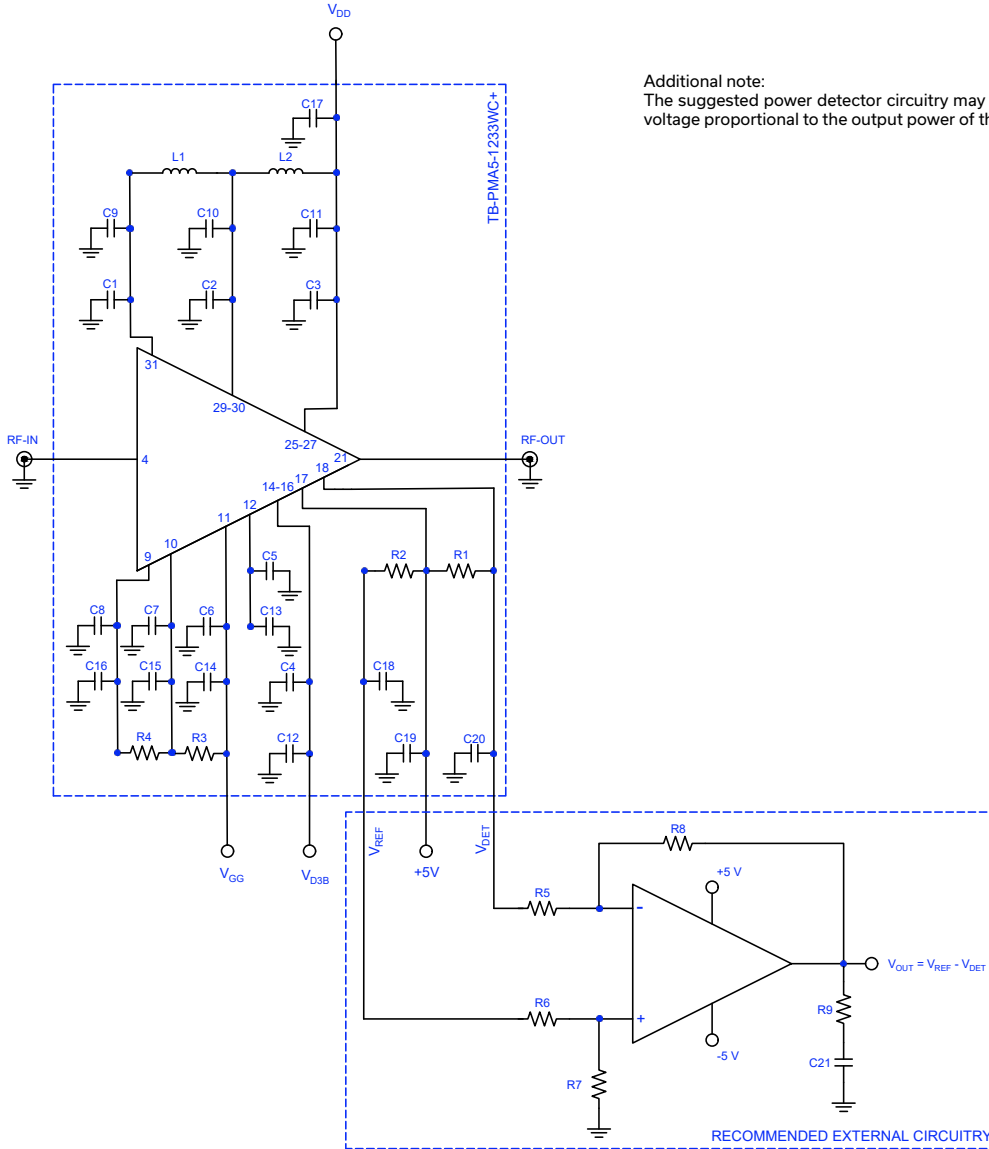

Additional note:

The suggested power detector circuitry may be used to provide a temperature compensated output voltage proportional to the output power of the device. +5 V must be applied at shunt capacitor C19.

Figure 3. PMA5-123-3W+ Characterization Circuit with Power Detector Circuitry

Component	Value	Size	Part Number	Manufacturer
R5-R8	10kΩ	0402	RK73H1ETTP1002F	KOA SPEER
R9	2.21Ω	0402	RK73H1ETTP2R21F	KOA SPEER
C21	4.7 μF	0805	08053C475KAT2A	KYOCERA AVX



CASE STYLE DRAWING

PCB Land Pattern

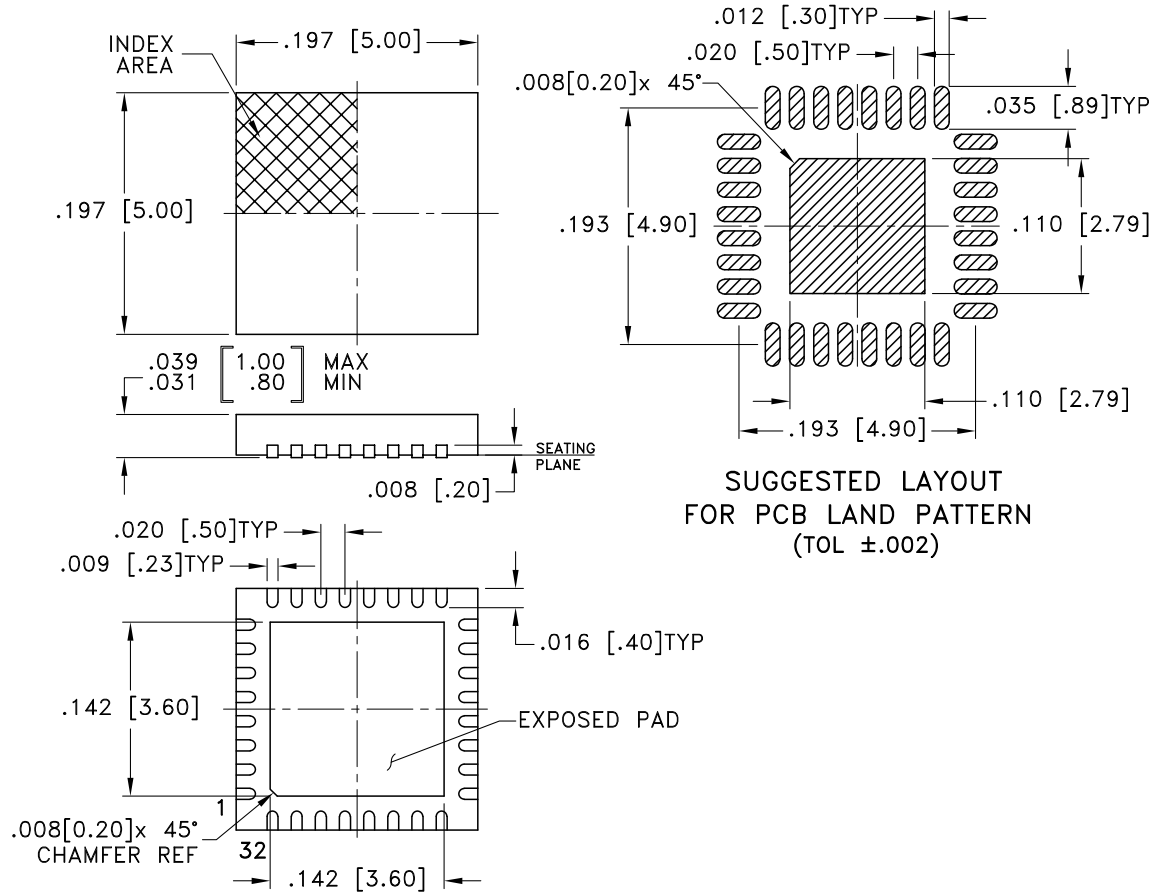

Weight: .05 grams

Dimensions are in inches [mm]. Tolerances: 2 Pl.±.01; 3Pl.±.005 Inch

PRODUCT MARKING

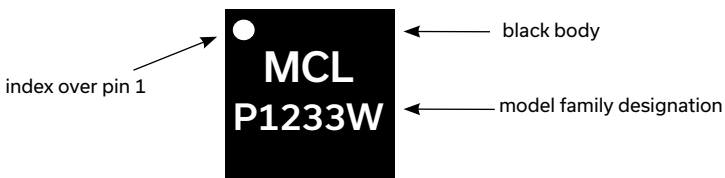

Marking may contain other features or characters for internal lot control



MMIC SURFACE MOUNT

Power Amplifier

PMA5-123-3W+

Mini-Circuits

50Ω 8 to 12 GHz 3.5 W P_{SAT}

ADDITIONAL DETAILED INFORMATION IS AVAILABLE ON OUR DASHBOARD [CLICK HERE](#)

Performance Data & Graphs	Data Graphs S-Parameter (S2P Files) Data Set (.zip file)
Case Style	DG1677-10 Plastic package, exposed paddle, Lead Finish: Matte-Tin
RoHS Status	Compliant
Tape & Reel Standard quantities available on reel	F68-1 7" reels with 10, 50, 100, 200, 500, 1K, or 2K 13" reels with 2K, 3K, or 4K
Suggested Layout for PCB Design	PL-783
Evaluation Board	TB-PMA5-1233WC+ Gerber File
Environmental Ratings	ENV08T1

- NOTES
- A. Performance and quality attributes and conditions not expressly stated in this specification document are intended to be excluded and do not form a part of this specification document.
 - B. Electrical specifications and performance data contained in this specification document are based on Mini-Circuit's applicable established test performance criteria and measurement instructions.
 - C. The parts covered by this specification document are subject to Mini-Circuits standard limited warranty and terms and conditions (collectively, "Standard Terms"); Purchasers of this part are entitled to the rights and benefits contained therein. For a full statement of the standard terms and the exclusive rights and remedies thereunder, please visit Mini-Circuits' website at www.minicircuits.com/terms/viewterm.html



Mouser Electronics

Authorized Distributor

Click to View Pricing, Inventory, Delivery & Lifecycle Information:

[Mini-Circuits:](#)

[PMA5-123-3W+](#)