



TGA2623

10 – 11 GHz 35 W GaN Power Amplifier

Product Overview

Qorvo's TGA2623 is an x-band, high power MMIC amplifier fabricated on Qorvo's production 0.25um GaN on SiC process (QGaN25).

The TGA2623 operates from 10 – 11 GHz and provides a superior combination of power, gain and efficiency. Achieving 35W of saturated output power with 27.5dB of large signal gain and 47% power-added efficiency, the TGA2623 provides the level of performance demanded by today's system architectures.

Depending on the system requirements, the TGA2623 can support cost saving initiatives on existing systems while supporting next generation systems with increased performance.

Lead-free and RoHS compliant.



Key Features

- Frequency Range: 10 – 11 GHz
- P_{SAT} ($P_{IN}=18$ dBm): 45.5 dBm
- P1dB: 41dBm @ Midband
- PAE ($P_{IN}=18$ dBm): > 47 %
- Power Gain ($P_{IN}=18$ dBm): 27.5 dB
- Small Signal Gain: 35 dB
- Bias: $V_D = 28$ V, $I_{DQ} = 290$ mA
- Pulsed V_D : PW = 100 us, DC = 10%
- Die Dimensions: 4.830 x 4.970 x 0.100 mm

Performance is typical across frequency. Please reference electrical specification table and data plots for more details.

Functional Block Diagram

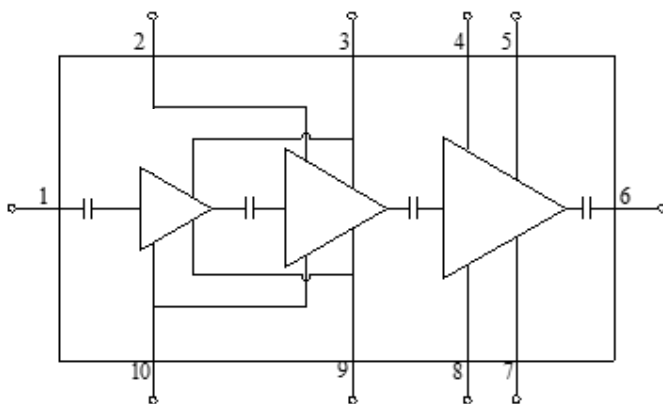

Applications

- X-Band Radar

Ordering Information

Part No.	Description
TGA2623	10 – 11 GHz 7 Watt GaN Amplifier
TGA2623EVB01	Evaluation Board for TGA2623

Absolute Maximum Ratings

Parameter	Value / Range
Drain Voltage (V_D)	40 V
Gate Voltage Range (V_G)	-5 V to 0 V
Drain Current (I_{D12})	2300 mA
Drain Current (I_{D3})	4300 mA
Gate Current (I_G)	See plot pg. 9
Power Dissipation (P_{DISS}), 85 °C, CW	96 W
Input Power (P_{IN}), 50 Ω , $V_D=28$ V, 85 °C	24 dBm
Input Power (P_{IN}), 6:1 VSWR, $V_D=28$ V, 85 °C	20 dBm
Soldering Temperature (30 s, max.)	320 °C
Storage Temperature	-55 to +150 °C

Operation of this device outside the parameter ranges given above may cause permanent damage. These are stress ratings only, and functional operation of the device at these conditions is not implied.

Recommended Operating Conditions

Parameter	Value / Range
Drain Voltage (V_D)	28 V
Drain Current (I_{DQ})	290 mA
Operating Temperature	-40 to +85 °C

Electrical specifications are measured at specified test conditions. Specifications are not guaranteed over all recommended operating conditions.

Electrical Specifications

Parameter	Min	Typ	Max	Units
Operational Frequency	10		11	GHz
Small Signal Gain		35		dB
Input Return Loss		15		dB
Output Return Loss		10		dB
Power Gain ($P_{in} = 18$ dBm)		27.5		dB
Output Power ($P_{in} = 18$ dBm)		45.5		dBm
Power Added Efficiency ($P_{in} = 18$ dBm)		47		%
Power @ 1dB Compression (P_{1dB} , Midband)		41		dB
Small Signal Gain Temperature Coefficient		-0.075		dB/°C
Recommended Operating Voltage:	20	28	32	V

Test conditions unless otherwise noted: 25 °C, $V_D = 28$ V, $I_{DQ} = 290$ mA, Pulsed V_D : PW = 100 us, DC = 10%

Performance Plots – Large Signal (Pulsed)

Test conditions unless otherwise noted: 25 °C, $V_D = 28\text{ V}$, $I_{DQ} = 290\text{ mA}$, Pulsed V_D : PW = 100 us, DC = 10%

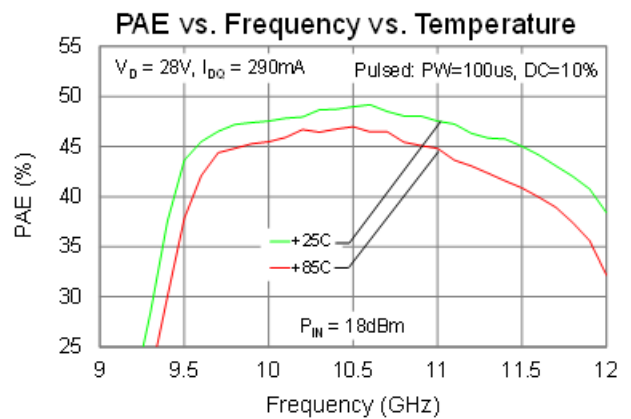
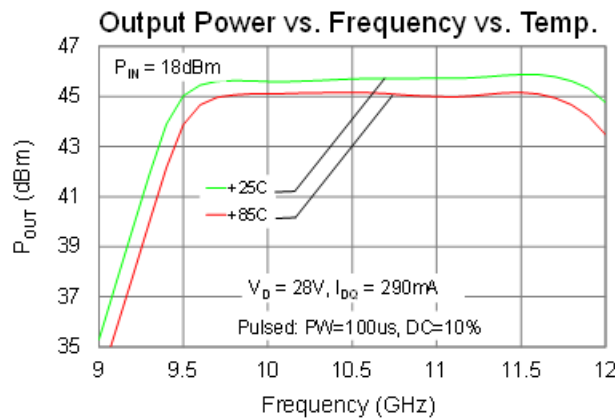
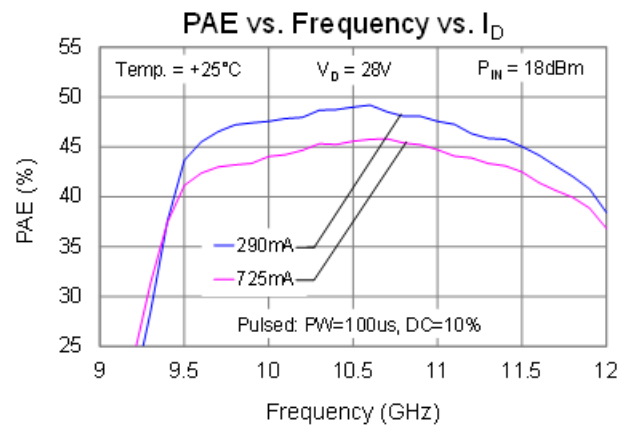
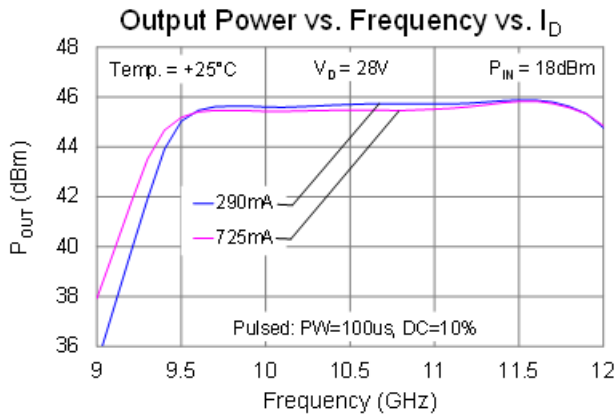
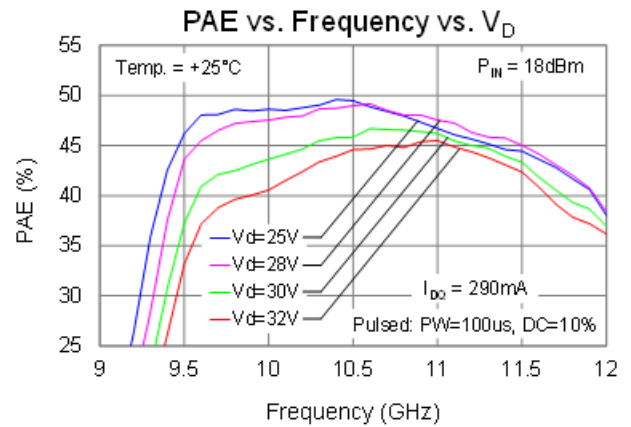
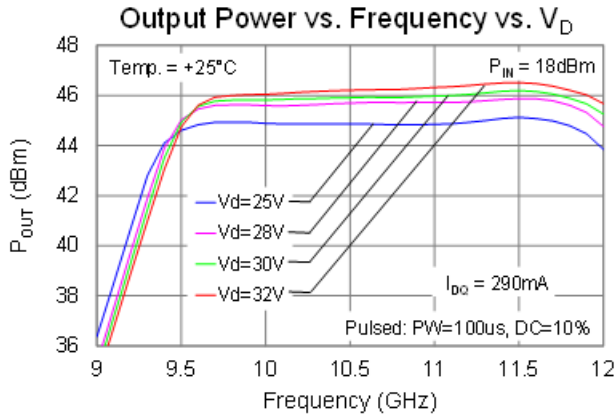

Performance Plots – Large Signal (Pulsed)

Test conditions unless otherwise noted: 25 °C, $V_D = 28\text{ V}$, $I_{DQ} = 290\text{ mA}$, Pulsed V_D : PW = 100 us, DC = 10%

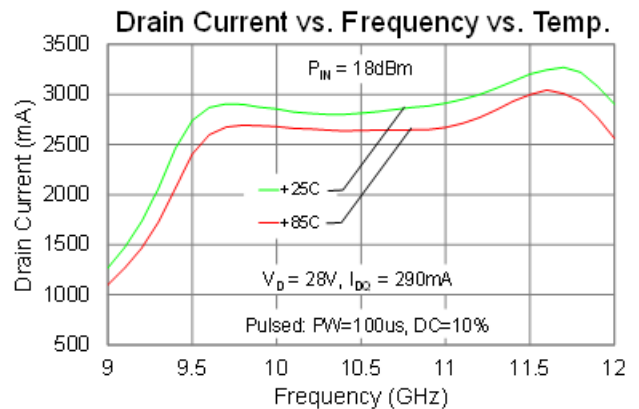
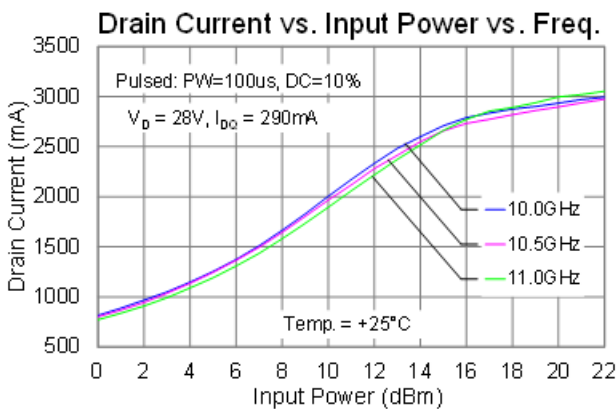
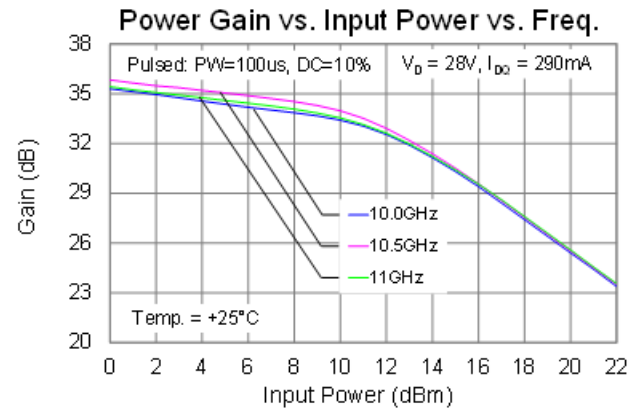
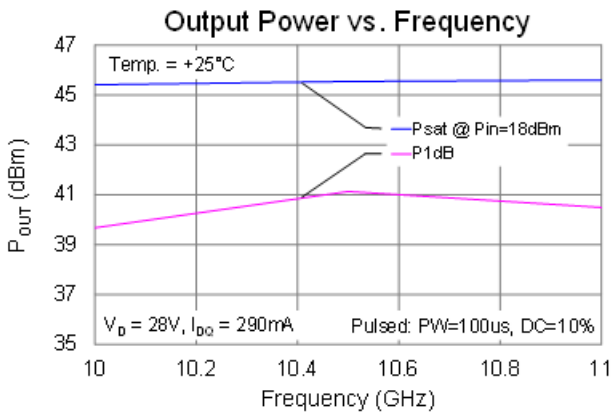
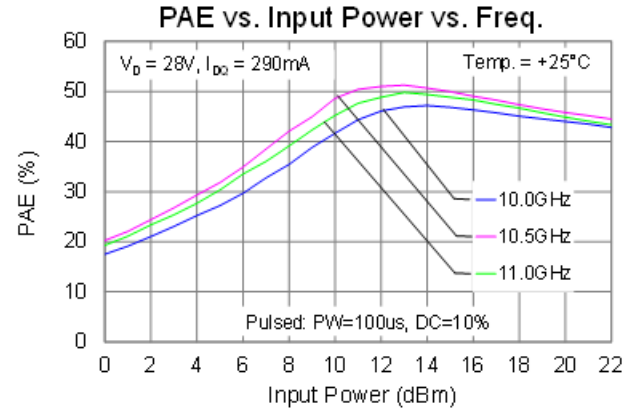
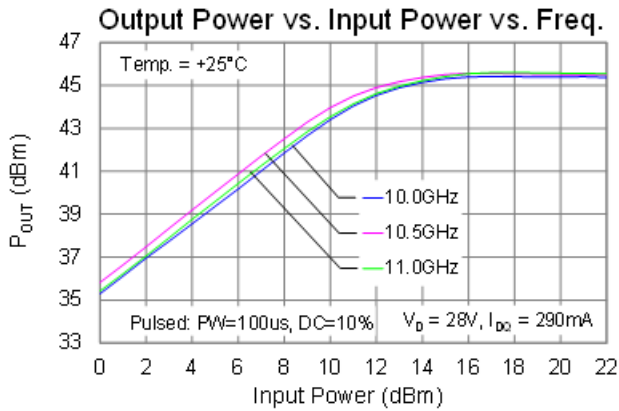

Performance Plots – Large Signal (CW)

Test conditions unless otherwise noted: 25 °C, $V_D = 28$ V, $I_{DQ} = 290$ mA, CW

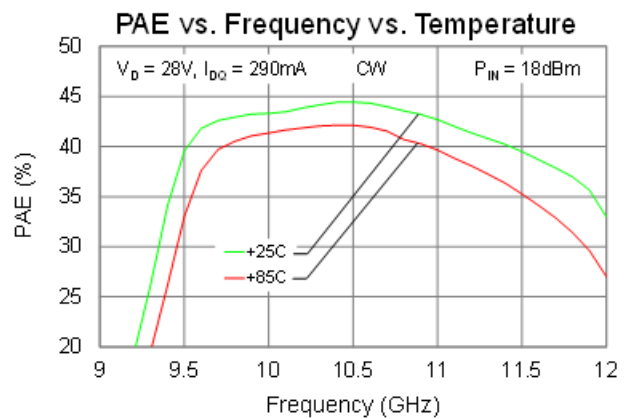
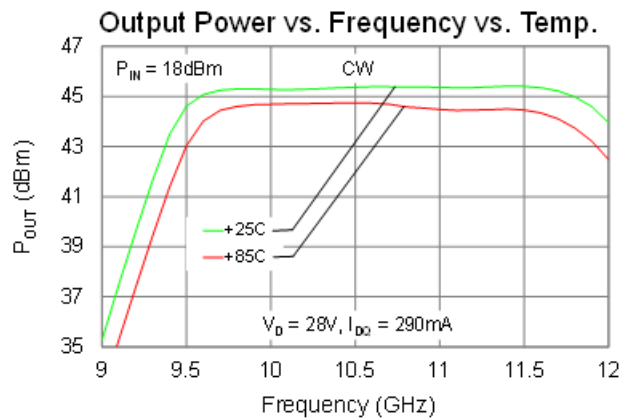
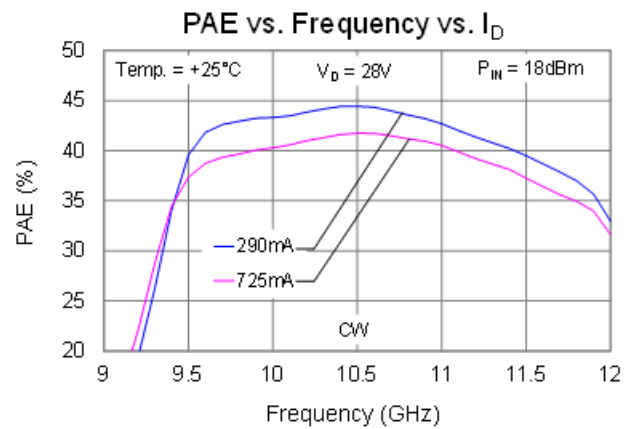
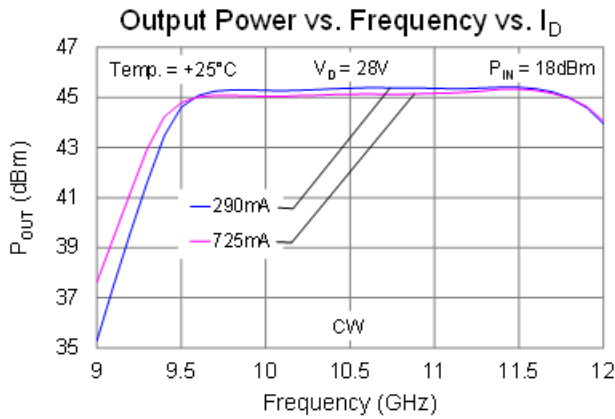
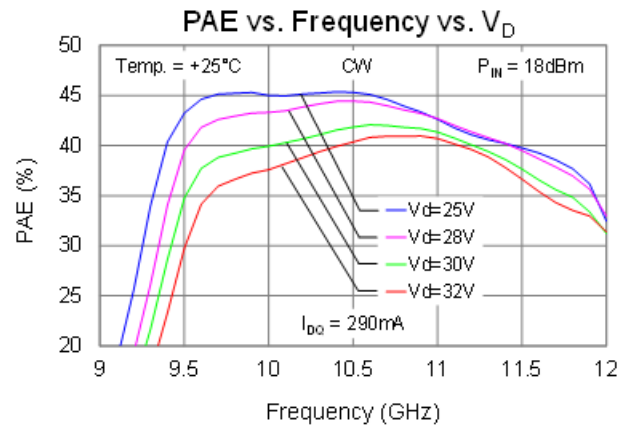
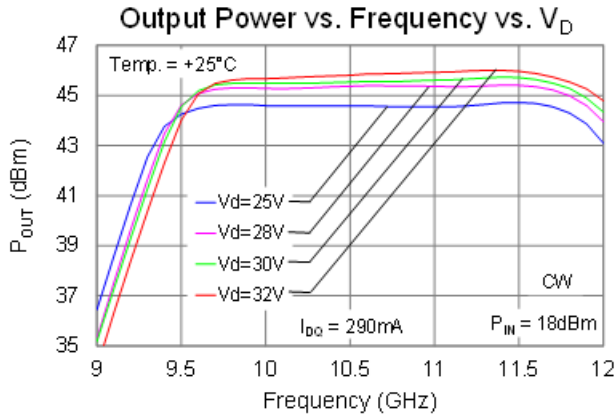

Performance Plots – Large Signal (CW)

Test conditions unless otherwise noted: 25 °C, $V_D = 28\text{ V}$, $I_{DQ} = 290\text{ mA}$, CW

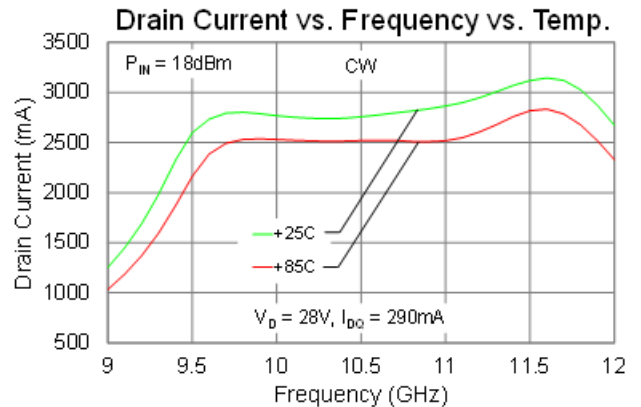
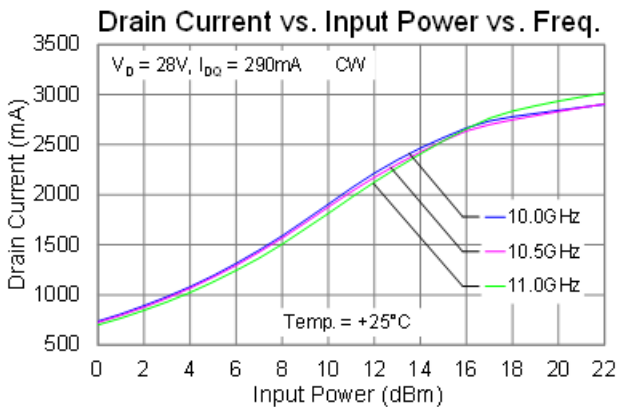
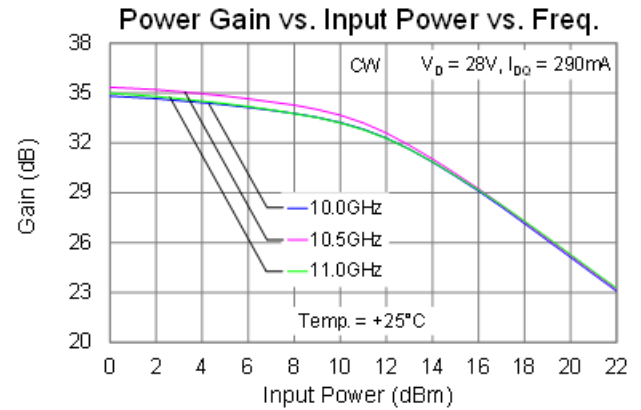
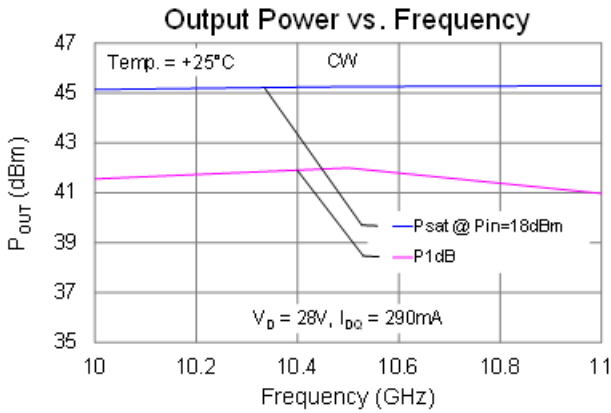
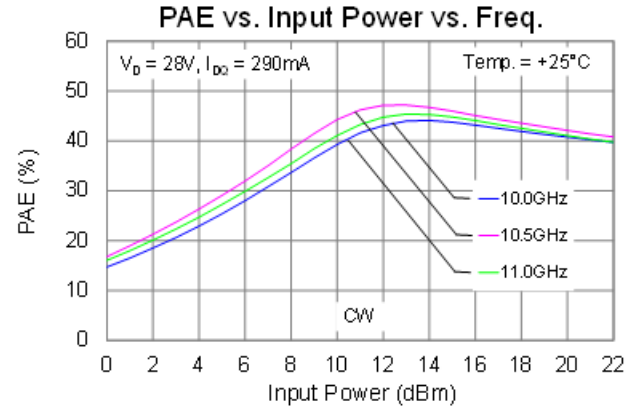
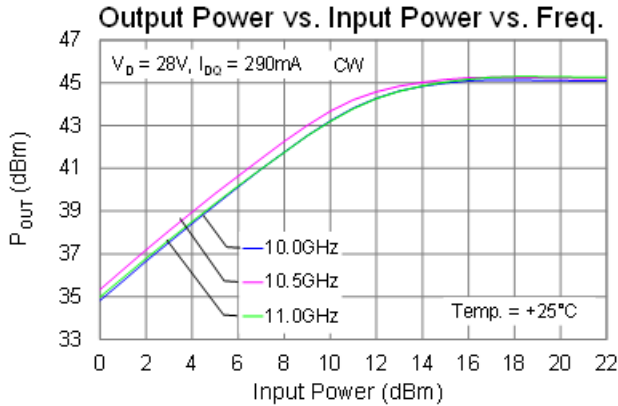

Performance Plots – Linearity

Test conditions unless otherwise noted: 25 °C, $V_D = 28\text{ V}$, $I_{DQ} = 290\text{ mA}$, CW

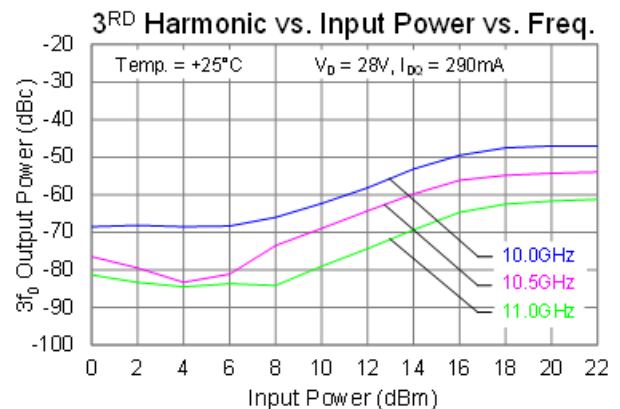
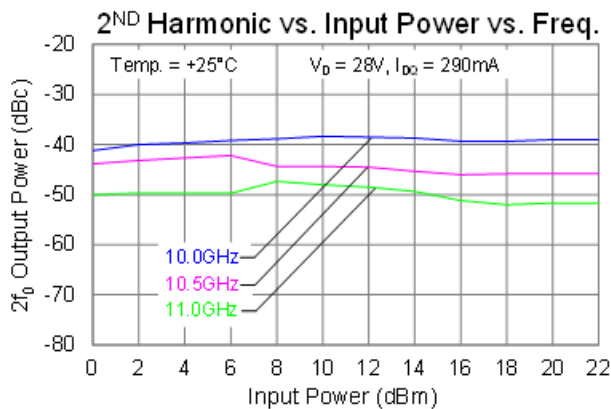
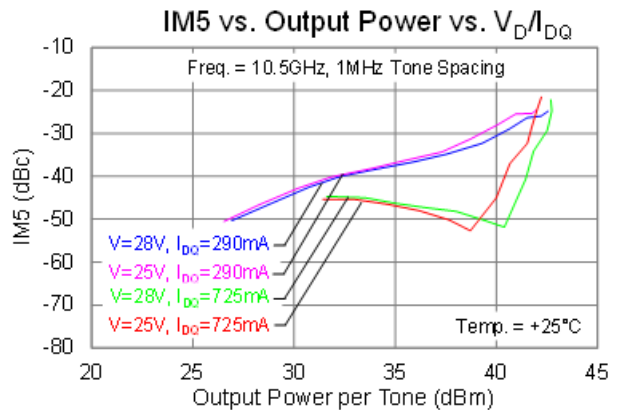
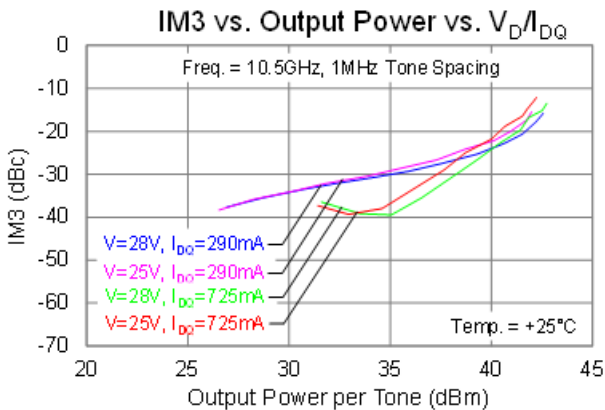
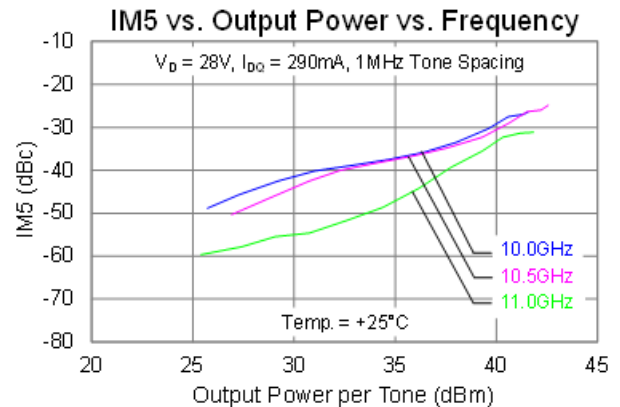
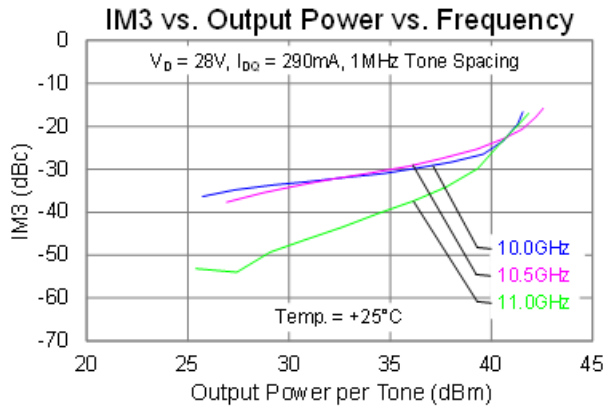

Performance Plots – Small Signal

Test conditions unless otherwise noted: 25 °C, $V_D = 28\text{ V}$, $I_{DQ} = 290\text{ mA}$, CW

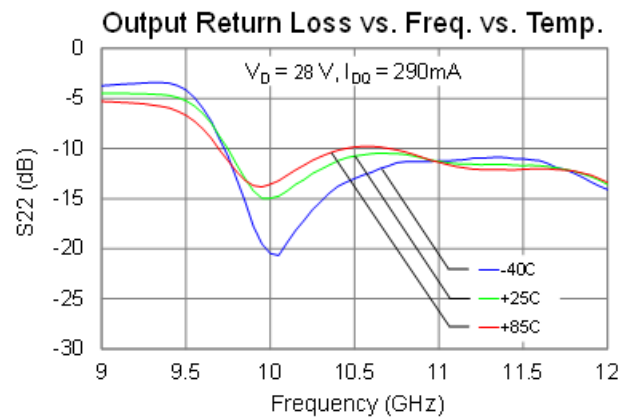
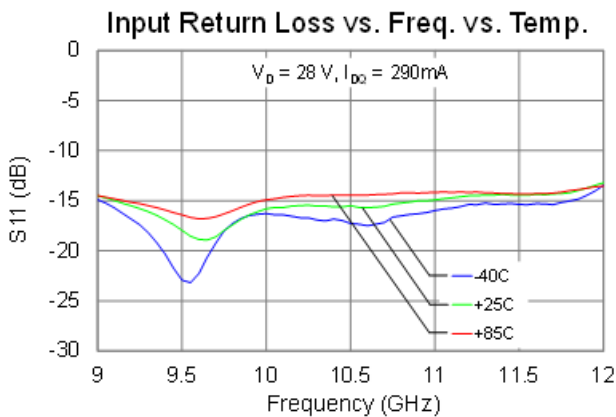
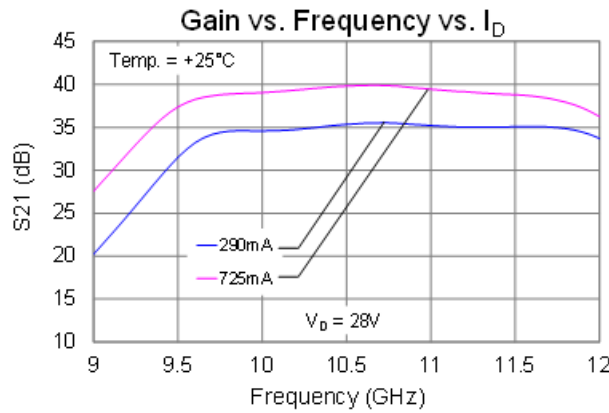
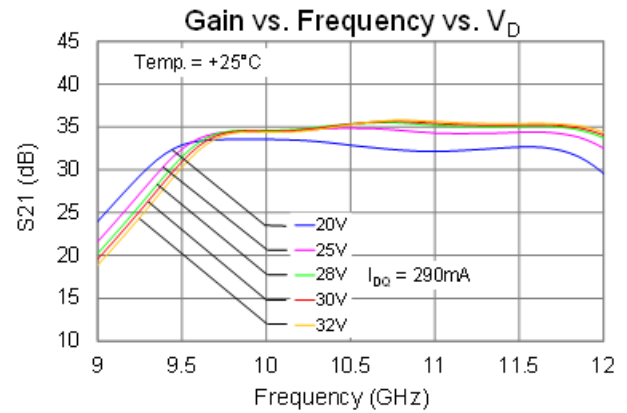
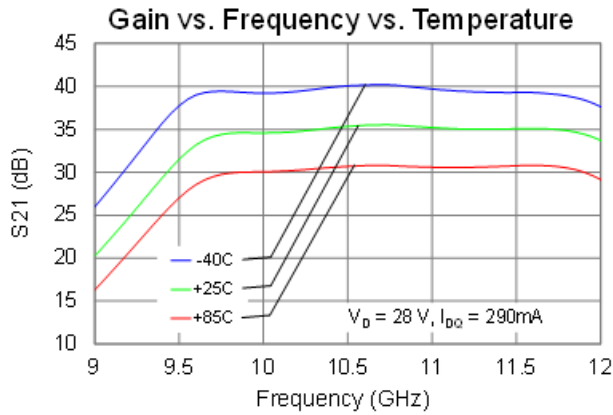

Thermal and Reliability Information

Parameter	Test Conditions	Value	Units
Thermal Resistance (θ_{JC}) ⁽¹⁾	$T_{BASE} = 85\text{ }^{\circ}\text{C}$, Pulsed V_D : PW = 100 us, DC = 10%	0.781	$^{\circ}\text{C}/\text{W}$
Channel Temperature, T_{CH} (Under RF) ⁽²⁾	$V_D = 28\text{ V}$, $I_{D_Drive} = 3.00\text{ A}$, $P_{IN} = 22\text{ dBm}$, $P_{OUT} = 45.3\text{ dBm}$, $P_{DISS} = 51\text{ W}$	124.8	$^{\circ}\text{C}$
Thermal Resistance (θ_{JC}) ⁽¹⁾	$T_{BASE} = 85\text{ }^{\circ}\text{C}$, CW, $V_D = 28\text{ V}$, $I_{D_Drive} = 2.94\text{ A}$,	1.305	$^{\circ}\text{C}/\text{W}$
Channel Temperature, T_{CH} (Under RF) ⁽²⁾	$P_{IN} = 22\text{ dBm}$, $P_{OUT} = 44.9\text{ dBm}$, $P_{DISS} = 52\text{ W}$	152.9	$^{\circ}\text{C}$

Notes:

1. Thermal resistance determined to the back of 40 mil CuMo carrier plate ($T_{BASE} = 85\text{ }^{\circ}\text{C}$)
2. °IR scan equivalent channel temperature. Refer to the following document: [GaN Device Channel Temperature, Thermal Resistance, and Reliability Estimates](#)

Dissipated Power and Maximum Gate Current

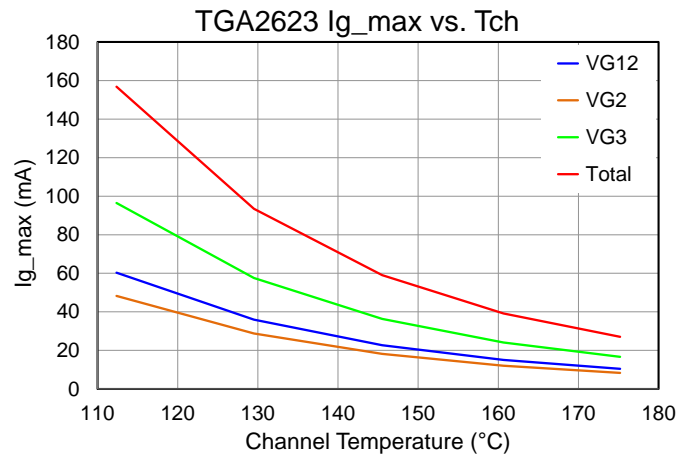
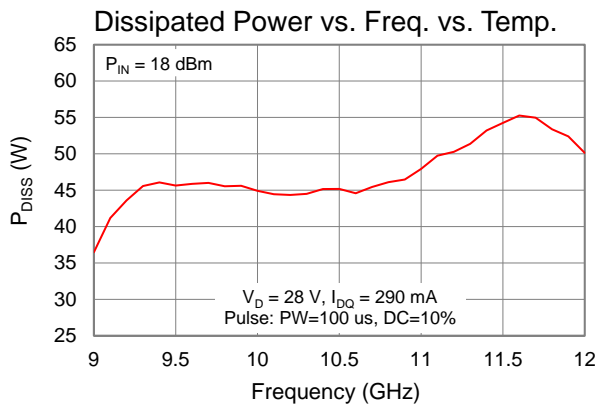

Test conditions unless otherwise noted: $25\text{ }^{\circ}\text{C}$, $V_D = 28\text{ V}$, $I_{DQ} = 290\text{ mA}$, Pulsed V_D : PW = 100 us, DC = 10%

Applications Information

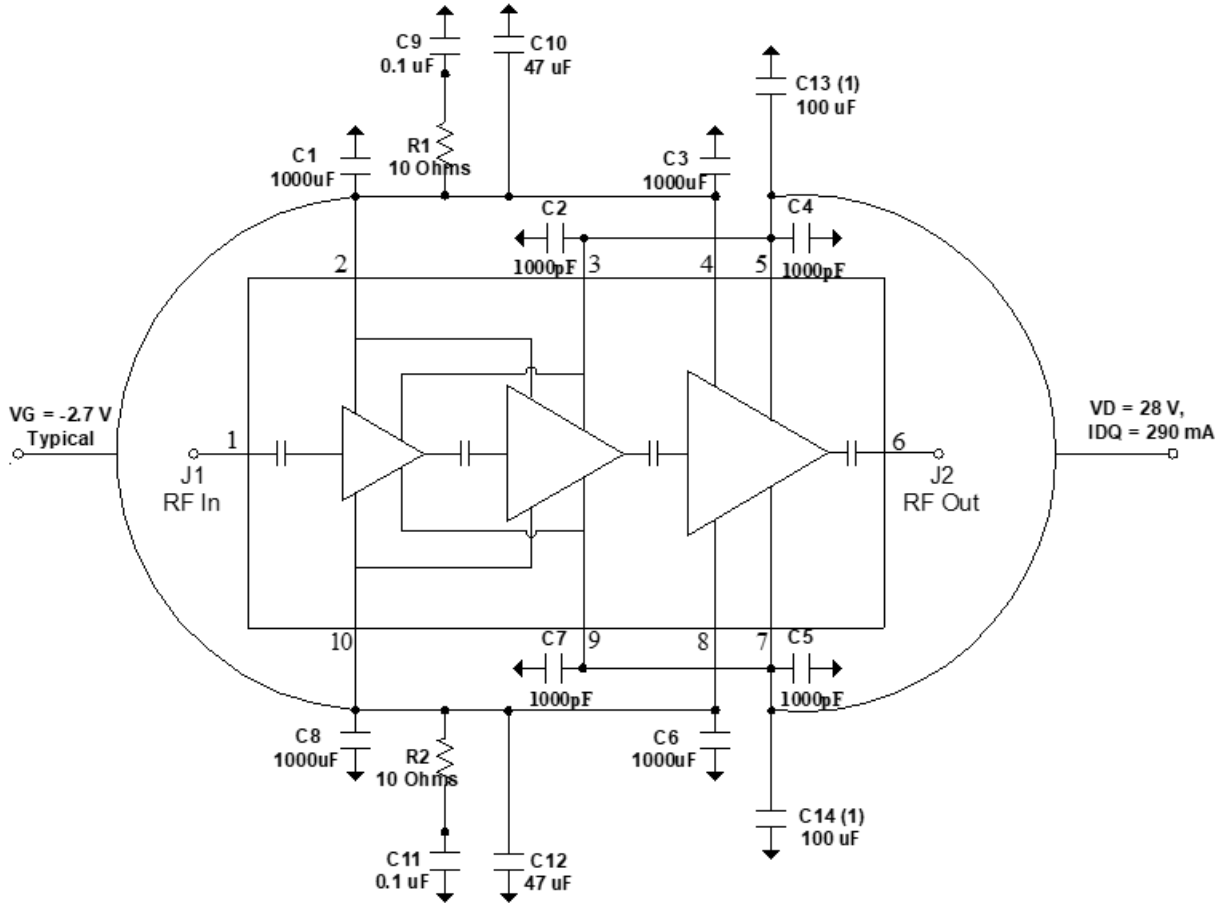

1. Remove caps for pulse operation. These caps are part of the cable harness for CW operation.

Bill of Materials

Reference Des.	Value	Description	Manuf.	Part Number
C1 – C8	1000pF	SLC, 50V	Various	
C9, C11	0.1uF	Cap, 0402, 50V, 10%, X7R	Various	
C10, C12	47uF	Cap, 1206, 50V, 10%, X7R	Various	
R1 – R2	10Ω	Res, 0402	Various	
R3 – R4	0Ω	Res, 0402	Various	

Evaluation Board (EVB) Layout Assembly

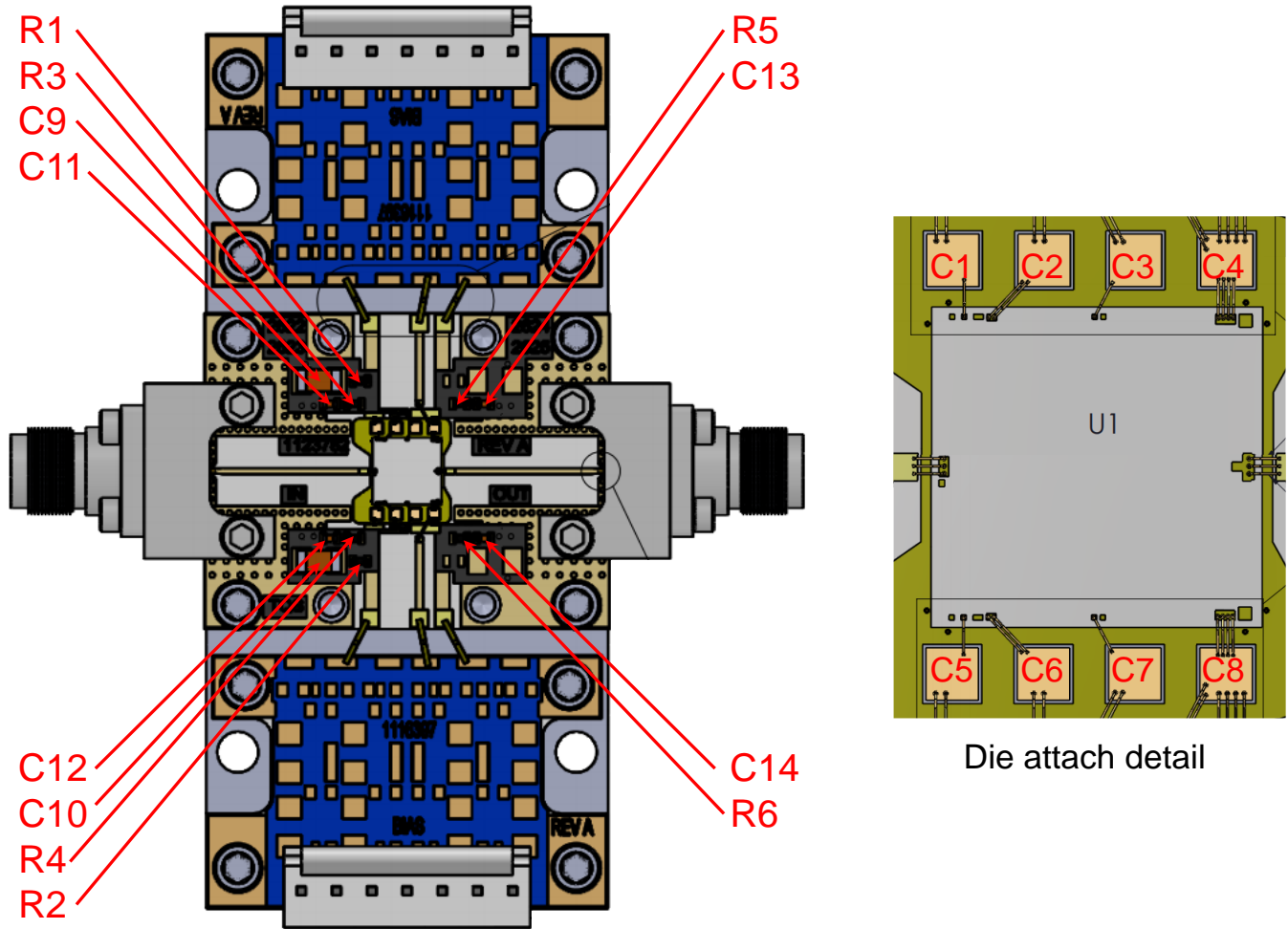

RF PCB is made from Rogers 4003C dielectric, .008 inch thick, 0.5 oz. copper both sides.

Bias-Up Procedure

1. Set I_D limit to 3.5A, I_G limit to 10mA
2. Set V_G to -5.0V
3. Set V_D +28V
4. Adjust V_G more positive until $I_{DQ} = 290mA$
5. Apply RF signal

Bias-Down Procedure

1. Turn off RF signal
2. Reduce V_G to -5.0 V. Ensure $I_{DQ} \sim 0$ mA
4. Set V_D to 0 V
5. Turn off V_D supply
6. Turn off V_G supply

Mechanical Information

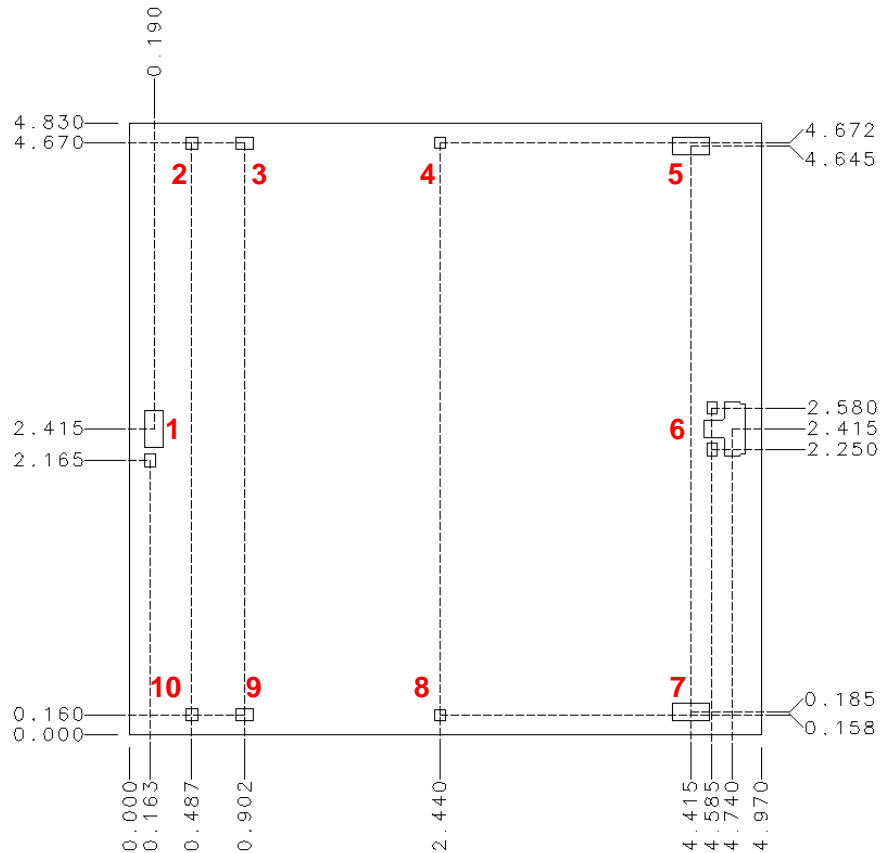

Dimensions are in mm
Thickness: 0.100
Die x, y size tolerance: ± 0.008
Ground is backside of die

Bond Pad Description

Pad	Symbol	Size ($\mu\text{m} \times \mu\text{m}$)	Description
1	RF IN	140 x 290	RF input. 50 Ohms. DC blocked
2	V_{G2}	90 x 90	Gate voltage stage 2. Bypass network required; refer to page 18.
3, 9	V_{D12}	140 x 90	Drain voltage stages 1 & 2. Bypass network required; refer to page 18.
4, 8	V_{G3}	85 x 85	Gate voltage stage 3. Bypass network required; refer to page 18.
5, 7	V_{D3}	290 x 140	Drain voltage stage 3. Bypass network required; refer to page 18.
6	RF OUT	120 x 430	RF output. 50 Ohms. DC blocked.
10	V_{G12}	90 x 90	Gate voltage stages 1 & 2. Bypass network required; refer to page 18.

Assembly Notes

Component placement and adhesive attachment assembly notes:

- Vacuum pencils and/or vacuum collets are the preferred method of pick up.
- Air bridges must be avoided during placement.
- The force impact is critical during auto placement.

Reflow process assembly notes:

- Use AuSn (80/20) solder and limit exposure to temperatures above 300 °C to 3–4 minutes, maximum.
- An alloy station or conveyor furnace with reducing atmosphere should be used.
- Do not use any kind of flux.
- Coefficient of thermal expansion matching is critical for long-term reliability.
- Devices must be stored in a dry nitrogen atmosphere.

Interconnect process assembly notes:

- Thermosonic ball bonding is the preferred interconnect technique.
- Force, time, and ultrasonic are critical parameters.
- Aluminum wire should not be used.
- Devices with small pad sizes should be bonded with 0.0007-inch wire.

Handling Precautions

Parameter	Rating	Standard
ESD – Human Body Model (HBM)	TBD	ANSI/ESD/JEDEC JS-001



Caution!

ESD-Sensitive Device

Solderability

Use only AuSn (80/20) solder, and limit exposure to temperatures above 300 °C to 3–4 minutes, maximum.

RoHS Compliance

This part is compliant with 2011/65/EU RoHS directive (Restrictions on the Use of Certain Hazardous Substances in Electrical and Electronic Equipment) as amended by Directive 2015/863/EU.

This product also has the following attributes:

- Lead Free
- Halogen Free (Chlorine, Bromine)
- Antimony Free
- TBBP-A (C₁₅H₁₂Br₄O₂) Free
- PFOS Free
- SVHC Free

Contact Information

For the latest specifications, additional product information, worldwide sales and distribution locations:

Web: www.qorvo.com

Tel: 1-844-890-8163

Email: customer.support@qorvo.com

Important Notice

The information contained herein is believed to be reliable; however, Qorvo makes no warranties regarding the information contained herein and assumes no responsibility or liability whatsoever for the use of the information contained herein. All information contained herein is subject to change without notice. Customers should obtain and verify the latest relevant information before placing orders for Qorvo products. The information contained herein or any use of such information does not grant, explicitly or implicitly, to any party any patent rights, licenses, or any other intellectual property rights, whether with regard to such information itself or anything described by such information. **THIS INFORMATION DOES NOT CONSTITUTE A WARRANTY WITH RESPECT TO THE PRODUCTS DESCRIBED HEREIN, AND QORVO HEREBY DISCLAIMS ANY AND ALL WARRANTIES WITH RESPECT TO SUCH PRODUCTS WHETHER EXPRESS OR IMPLIED BY LAW, COURSE OF DEALING, COURSE OF PERFORMANCE, USAGE OF TRADE OR OTHERWISE, INCLUDING THE IMPLIED WARRANTIES OF MERCHANTABILITY AND FITNESS FOR A PARTICULAR PURPOSE.**

Without limiting the generality of the foregoing, Qorvo products are not warranted or authorized for use as critical components in medical, life-saving, or life-sustaining applications, or other applications where a failure would reasonably be expected to cause severe personal injury or death.

Copyright 2021 © Qorvo, Inc. | Qorvo is a registered trademark of Qorvo, Inc.

Mouser Electronics

Authorized Distributor

Click to View Pricing, Inventory, Delivery & Lifecycle Information:

[Qorvo:](#)

[TGA2623](#)